

# FOCUS DENTAL

NAJBOLJA PONUDA PROIZVODA ZA  
VAŠU DENTALNU ORDINACIJU



+385 91 619 7408



SLAVKA KRAUTZEKA 66D, RIJEKA



WWW.FOCUSDENTAL.HR



INFO@FOCUSDENTAL.HR

# ENDO *love*

FOCUS DENTAL

♥ ENDOLOVE – STRAST PREMA ENDODONCIJI ♥

ENDODONCIJA JE NAŠA STRAST, A PODIZANJE SVIJEŠTI O VAŽNOSTI OČUVANJA PRIRODNIH ZUBA NAŠA MISIJA.

◆ SVOJU LJUBAV PREMA ENDODONCIJI PRETOČILI SMO U PROJEKT ENDOLOVE, KROZ KOJI PROMIČEMO EDUKACIJU O NAJNOVIJIM I INOVATIVNIM TRENDOVIMA U STRUCI.

◆ VJERUJEMO DA JE KLJUČ USPJEHA U SURADNJI S VODEĆIM STRUČNJACIMA TE U PONUDI EDUKACIJA I PROIZVODA ODOBRENIH OD STRANE STRUKE.

📣 PRIDRUŽITE SE ENDOLOVE POKRETU!

POSTANITE DIO ZAJEDNICE KOJA VAM DONOSI:

✓ TEORIJSKO-PRAKTIČNE RADIONICE (GRUPNE I INDIVIDUALNE)

✓ EDUKACIJU ZA POČETNI I NAPREDNI STUPANJ

✓ NAJNOVIJE INFORMACIJE O TRENDOVIMA U ENDODONCIJI

♥ NAŠ CILJ? DIJELITI ZNANJE, ŠIRITI SVIJEŠTI I POTAKNUTI ONO ŠTO NAS NAJVIŠE POKREĆE:

✨ LJUBAV PREMA ENDODONCIJI – ENDOLOVE ✨

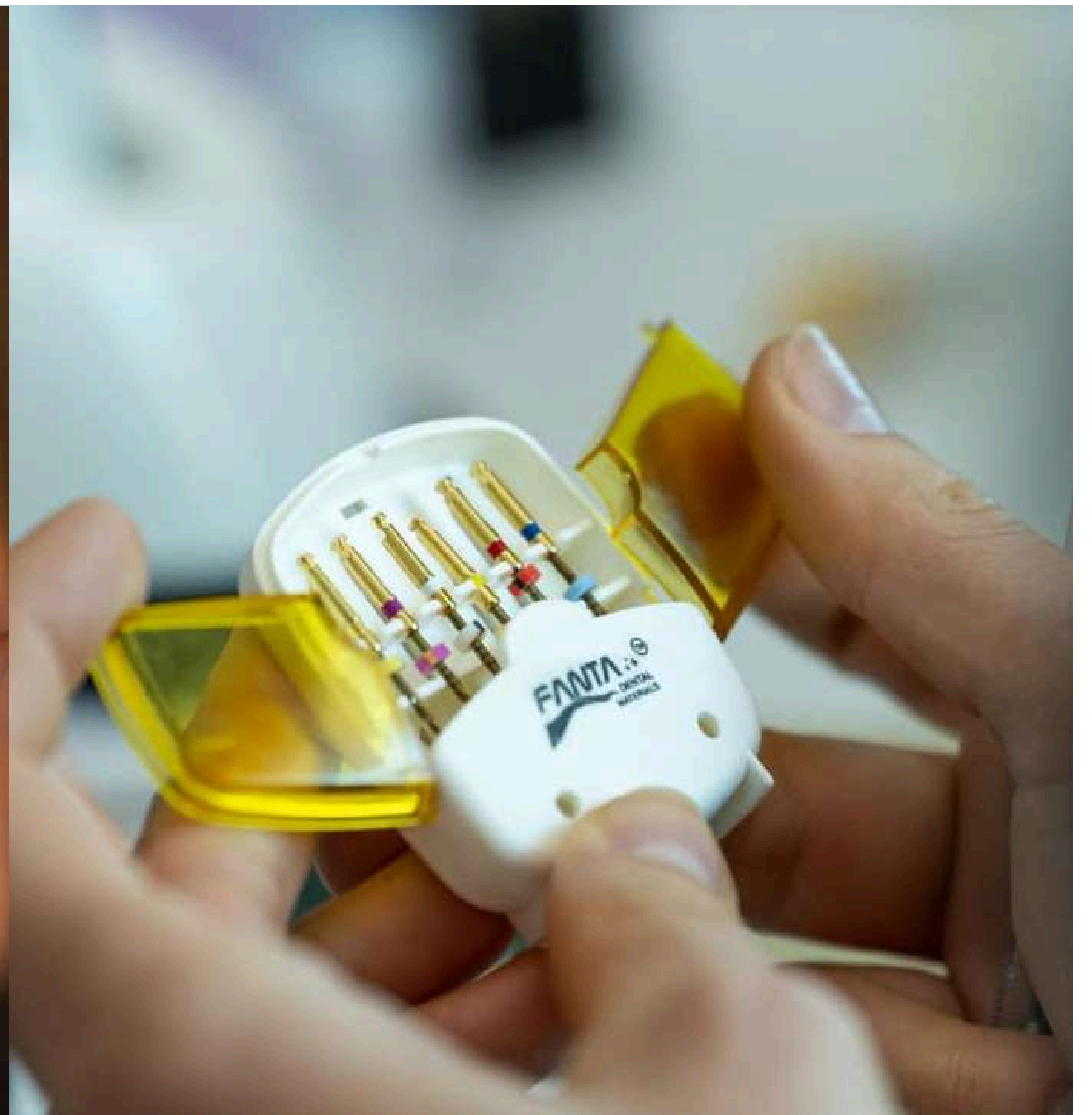

# EIGHTEETH ENDOMOTOR E-CONNECT S



## PROGRAMI RADA

- FWD - ROTACIJA
- REW - REVIZIJA
- REC - RECIPROČNA TEHNIKA
- ATC - AKTIVNA KONTROLA SNAGE

## NAPREDNE FUNKCIJE

- AUTO START- STOP
- APICAL REVERSE
- APICAL SLOW DOWN

## SPECIFIKACIJE

- BRZINA: 120 - 1000 RPM
- SNAGA: 0.5 - 4.0 NCM
- BATERIJA: 1500 MAH

INTEGRIRANI APEX LOKATOR ←

10 MEMORIJA ZA PROGRAMIRANJE ←

360 ROTIRAJUĆA GLAVA



997,08 € + PDV

CIJENA S UKLJUČENIM PDV-OM  
1.246,35 €

+ GRATIS START PAKET

# EIGHTEETH ENDOMOTOR E-XTREME



## PROGRAMI RADA

- FWD - ROTACIJA
- REW - REVIZIJA
- REC - RECIPROČNA TEHNIKA

## SPECIFIKACIJE

- BRZINA: 120 - 650 RPM
- SNAGA: 0.5 - 4.0 NCM
- BATERIJA: 800 MAH
- TEŽINA: 99 GRAMA

600,00 € + PDV

CIJENA S UKLJUČENIM PDV-OM  
750,00 €

# APEX LOKATOR - FINDPEX

Nova generacija Apex lokatora

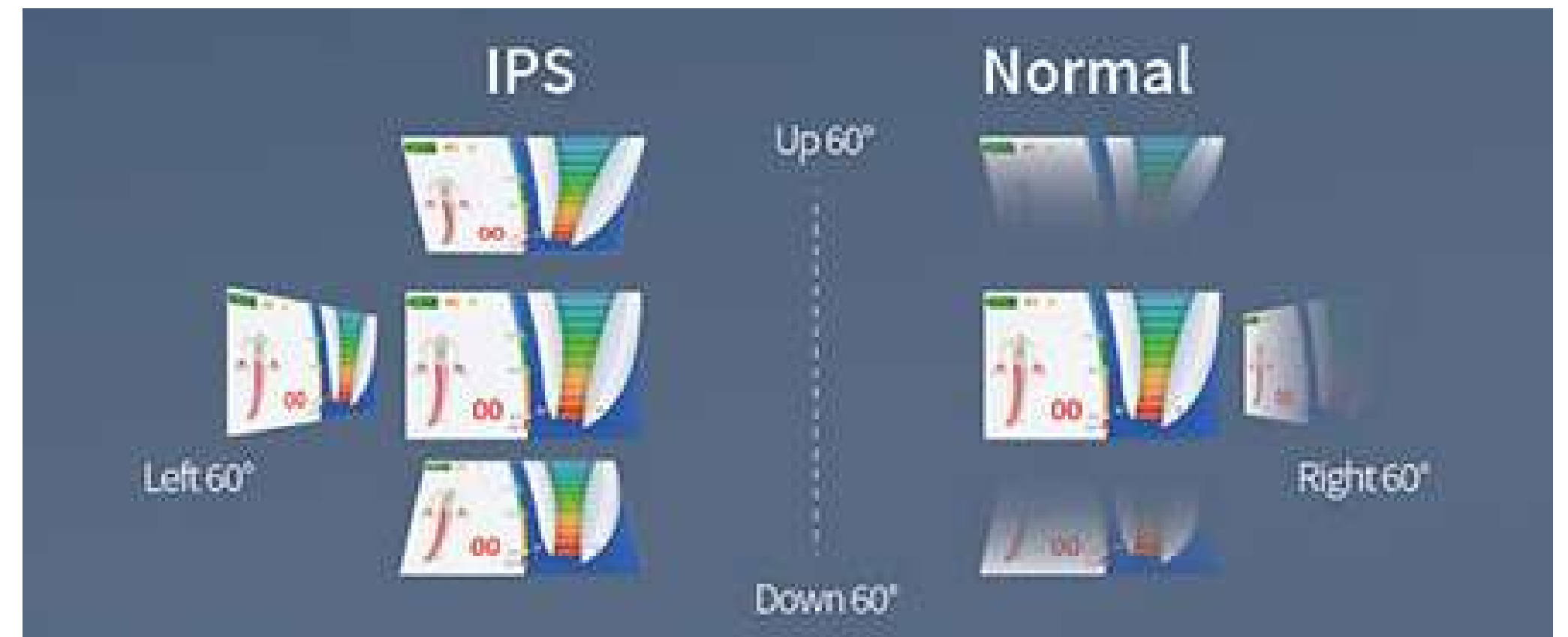

Patentirana ASW tehnologija omogućuje nesmetano i stabilno mjerenje u kompleksnim kanalima

- 8,89 cm TFT ekran u boji vidljiv iz zahtjevnih kuteva
- Dimenzije uređaja 156 mm x 106 mm x 114mm
- Litij-ionska baterija, 3.7V/800mAh
- Težina 247 g

350,00 € + PDV

CIJENA S UKLJUČENIM PDV-OM  
437,50 €

## EIGHTEETH – E-PEX LOCATOR

- NAPREDNA VIŠEFREKVENTNA TEHNOLOGIJA;
- VISOKA PRECIZNOST U MOKRIM I SUHIM KANALIMA;
- VELIKI 3,5 LCD ZASLON;
- AUTOMATSKA KALIBRACIJA;
- KOMPAKTNA VELIČINA I STABILAN DIZAJN;
- SNAŽNA LITIJ-IONSKA BATERIJA OD 1500 MAH.



177,00 € + PDV

CIJENA S UKLJUČENIM PDV-OM  
221,25 €

## EIGHTEETH AIRPEX WIRELESS APEX LOCATOR

- OSJETITE ČARI BEŽIČNOG PUNJENJA
- WIRELESS APEX LOKATOR



284,00 € + PDV

CIJENA S UKLJUČENIM PDV-OM  
355,00 €

# FAST PACK

## OPTURACIJSKI SISTEM

- Podesiva temperatura od 90°C - 300°C
- Pet programa za podešavanje temperature

### VRIJEME ZAGRIJAVANJA:

- 0,2 sekunde do 200°C
- 0,5 sekunda do 250°C

### VRIJEME HLAĐENJA:

- 2 sekunde

### ZAGRIJAVANJE SAMO RADNOG DIJELA UREĐAJA

- Ostatak je hladan, sprečavajući opekline mekog tkiva

### TRI 360 ROTIRAJUĆA NASTAVKA

- Small 40/0,025
- Medium 50/0,05
- Large 60/0,06

### IZUZETNO DUGOTRAJNA BATERIJA: 2600 MAH

- Do 4 sata kontinuiranog rada na temperaturi od 250°C



495,00 € + PDV

CIJENA S UKLJUČENIM PDV-OM  
**618,75 €**

# FAST FILL

## OPTURACIJSKI SISTEM

### SPECIFIKACIJE

- vrijeme zagrijavanja 20 sekundi do 200°C
- vrijeme punjenja 4 sata
- baterija 2600 mAh



Dva 360° rotirajuća nastavka

- G23
- G25

Konstantan tok GP po programiranoj jačini

- Tri podesiva programa: T1-T3
- Temperatura od 100°C - 200°C
- Podesivi tok GP
- Indikator preostale GP u uređaju

### GUTTA PERCHA ZA TOPLINSKO PUNJENJE KANALA



48,00 € + PDV

60,00 €

38,40 € + PDV

48,00 €

CIJENA S UKLJUČENIM PDV-OM

-20%

615,70 € + PDV

CIJENA S UKLJUČENIM PDV-OM

769,63 €



# EIGHTEETH ULTRAX

## BEŽIČNI ULTRASONIČNI AKTIVATOR

### SPECIFIKACIJE:

- Uređaj za ultrasoničnu aktivaciju
- Razni nastavci
- Lagan i ergonomski
- 1500 mAh, litijska baterija – Trajanje do 4.5 sata neprestanog rada
- 2 načina rada s LED indikatorom
- 45 kHz High Frequency



Application Based  
multiple Tips

Contra-angle Desing

Two Power Modes  
with LED Indicator

395,00 € + PDV

CIJENA S UKLJUČENIM PDV-OM  
493,75 €



## LUPE BRILLIANCE 48° PRO

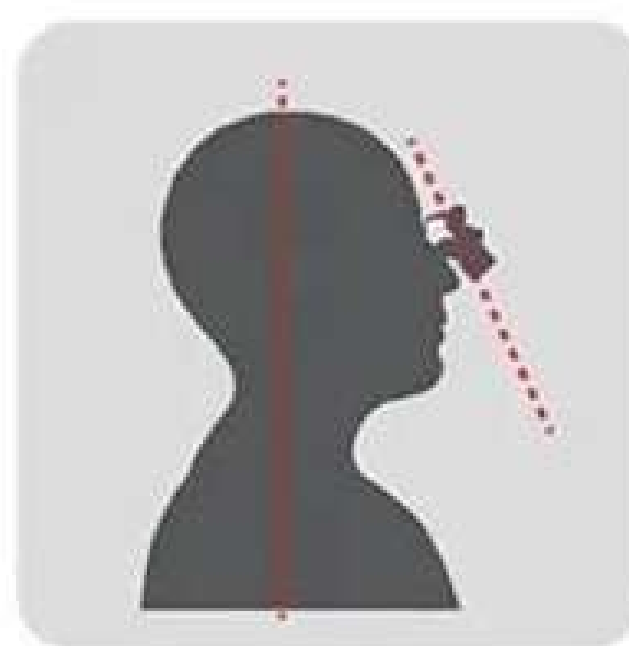

- ERGONOMSKI OBLIKOVANO
- OPTIKA S POVEĆANJEM 5.0X PUTA
- STAKLA KOJA OSIGURAVAJU VISOKU KVALITETU SLIKE
- MOGUĆNOST STAVLJANJA DIOPTRIJSKIH LEĆA

1.200,00 € + PDV

CIJENA S UKLJUČENIM PDV-OM  
**1.500,00 €**

## LUPE BRILLIANCE



- ERGONOMSKI OBLIKOVANO
- OPTIKA S POVEĆANJEM DO 3.0X - 3.5X PUTA
- STAKLA KOJA OSIGURAVAJU VISOKU KVALITETU SLIKE
- MOGUĆNOST STAVLJANJA DIOPTRIJSKIH LEĆA

360,00 € + PDV

CIJENA S UKLJUČENIM PDV-OM  
**450,00 €**

## SVJETLO SOFTOUCH



432,00 € + PDV

CIJENA S UKLJUČENIM PDV-OM  
**540,00 €**

## WIRELESS-Z SVJETLO



612,00 € + PDV

CIJENA S UKLJUČENIM PDV-OM  
**765,00 €**



# OPERACIJSKI MIKROSKOP - ACUVISION X

Ergonomski dizajn sa preklopnim okularom, podešavanje razmaka zjenica, te podešavanje hvatišta

**Ugrađen Sony High-Definition slikovni sustav:**

- slikajte i snimajte slučajeve u viskoj rezoluciji 1920\*1080, 60 FPS
- unutarnja memorija 64 GB



- Povećanje 2.6x, 3.9x, 6.3x, 9.8x, 15.7x, 23.5x
- Radna udaljenost 190mm-460mm
- Led svjetlo jačine 80,000 lx
- Radni vijek od 60,000 radnih sati
- Promjer svjetla do 210 mm

11.600,00 € + PDV

CIJENA S UKLJUČENIM PDV-OM  
14.500,00 €

# APLIKATOR ANESTEZIJE, E-FLOW

Patentirana tehnologija hidrauličnog pogona sa visoko preciznim sensorima istiskivanja anestezije



- Pametna nožna pedala omogućuje mijenjanje brzine istiskivanja, dok smart-lock sustav održava zadanu brzinu istiskivanja neovisno o jačini pritiska na pedalu



→ Posuda za ampulu se autoklavira



→ **Aspiracija**

Spriječite oticanje i bol uzrokovane prekomjernom količinom anestezije

→ **Lakši i manji**

Teži samo 40g. lagan za rukovanje

**4 programa sa višestrukim opcijama:**

- normalno istiskivanje
- brzo istiskivanje
- PDL (periodontalni ligament)
- doziranje

**Brzine istiskivanja:**

- sporo 0,3ml/min
- normalno 1,7ml/min
- brzo 3,5ml/min

- Uređaj dolazi sa 4x posude za ampule, te 5x gumenih prstena

1.440,00 € + PDV

CIJENA S UKLJUČENIM PDV-OM

**1.800,00 €**

# FIZIODISPENZER - MOTORSURG

- Siguran i stabilan pod visokim opterećenjima
- 8 potpuno prilagodljivih programa po želji korisnika
- Snimanje parametara zahvata te prebacivanje na USB
- LED ekran osjetljiv na dodir
- Podešavanje jačine LED svjetla na koljičniku

## SPECIFIKACIJE UREĐAJA:

Speed(rpm)	200-40,000
Torque(N·cm)	5-80
Max. pump output(ml/min)	130
Program	8
Screen	LED color touch
One-button calibration	Yes
Light	White LED
Luminance(lux)	over 32,000
Length of motor cable(m)	2
Volume(cm)	24x26.5x15
Weight(kg)	3.65
Power supply	220-240V & 100-120V 50/60Hz

## Multifunkcionalna nožna pedala:

1. Start/Stop
2. Kontrola toka tekućine do 130ml/min
3. Kontrola programa
4. Kontrola rotacije



→ **STRONG CONTRA ANGLE**

2.112,00 € + PDV

CIJENA S UKLJUČENIM PDV-OM  
**2.640,00 €**



# PRVI SPOJ UMJETNE INTELIGENCIJE SA STOMATOLOGIJOM U SVIJETU!

## NANO PIX RTG SENZOR + AI SOFTWARE

Kompatibilno sa gotovo svim AC i DC rendgenima

APS COMOS tehnologija iz zrakoplovne industrije koja omogućuje:

- visoki omjer signala i šuma (SNR) za maksimalne detalje
- dug radni vijek uz minimalnu potrošnju
- Niska doza zračenja, kraće vrijeme izlaganja uz visoku kvalitetu slike
- Uz kupnju senzora dolazi gratis program za obradu slika

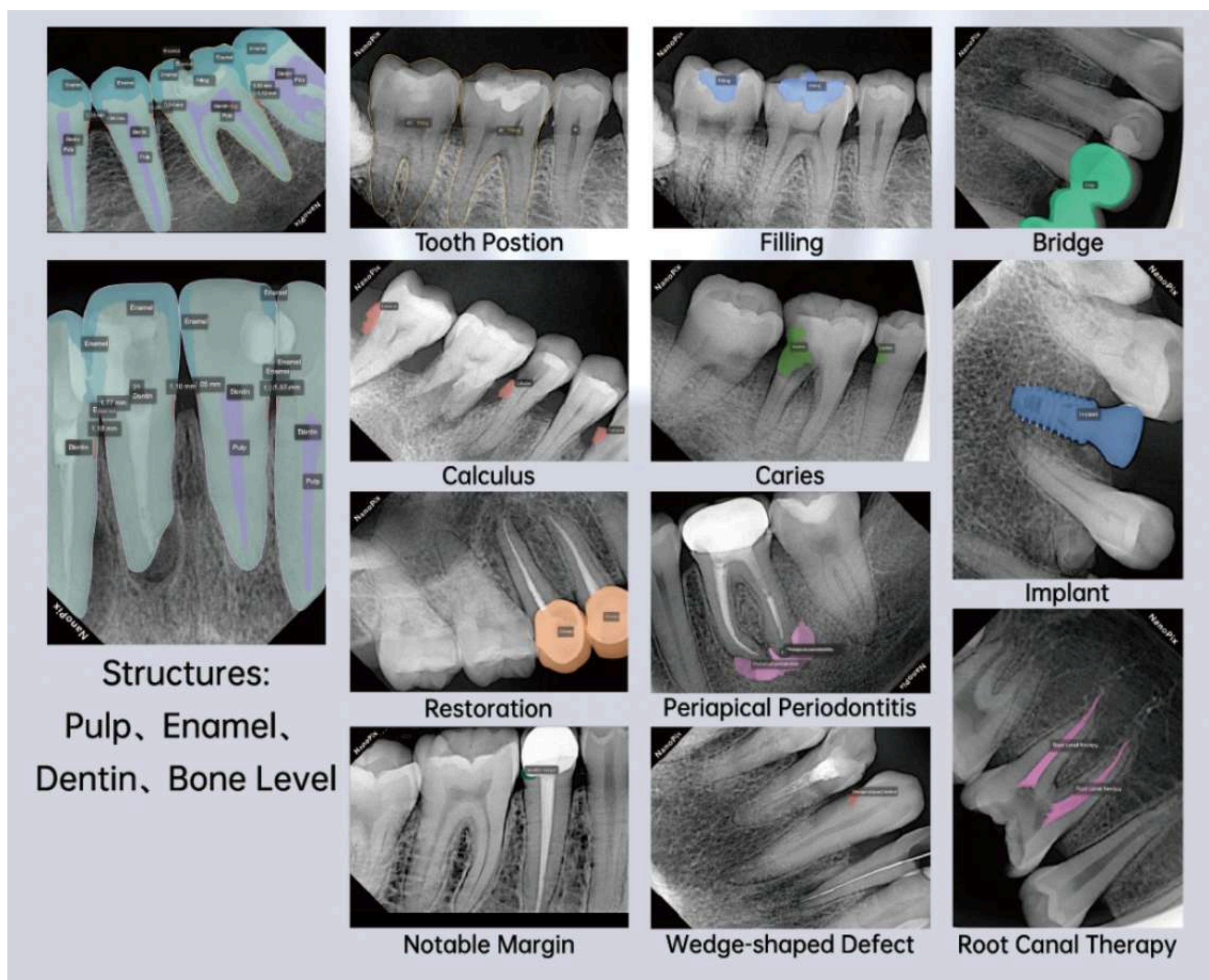

Preciznost umjetne inteligencije

# 93%

Prvi dijagnostički program sa umjetnom inteligencijom koji detektira:

- 4 strukture zuba (pulpa, enamel, dentin, strukturu kostiju)
- 10 bolesti zuba
- automatsko određivanje pozicije zuba

### NANO PIX 1

1.347,50 € + PDV

CIJENA S UKLJUČENIM PDV-OM  
**1.684,38 €**

+ GRATIS dijagnostički program +

### NANO PIX 2

1.617,00 € + PDV

CIJENA S UKLJUČENIM PDV-OM  
**2.021,25 €**

# EIGHTEETH MIKROMOTOR BEZ ČETKICA, MOTOTURBO

Visoka snaga te visok i stabilan okretni moment

- 4 omjera prijenosa (1:5 1:1 16:1 20:1)
- 4 konektora, čineći ga pogodnim za sve tipove stomatoloških stolica
- LCD ekran osjetljiv na dodir
- Podešavanje jačine LED svjetla na instrumentu

## 4 prilagodljiva memorijska programa (M1-M4)

- kontrola rotacije
- kontrola brzine
- kontrola okretnog momenta

- Ergonomski dizajn
- Sustav hlađenja čini svrdlo hladnim
- Smanjena razina vibracija te neprekidna rotacija za pedantne i precizne radove



- Tehnologija bez četkica sa jakim sustavom hlađenja pruža pacijentu ugodnu temperaturu pri liječenju
- Izuzetno tih, naspram ostalih mikromotora

1.238,00 € + PDV

CIJENA S UKLJUČENIM PDV-OM

**1.547,50 €**

# E-SANIT AUTOKLAV

- Patentirana antisifon tehnologija koja sprječava povrat vode
- Ugrađeni senzori detektiraju manjak vode te mjere kakvoću vode u uređaju
- Integrirani Dual senzori koji sprječavaju pregrijavanje instrumenata i detektiraju abnormalne promjene u temperaturi
- Dostupni u 2 zapremnine - 18 litara i 23 litre

## 8 različitih programa:



GENERAL B



RAPID S

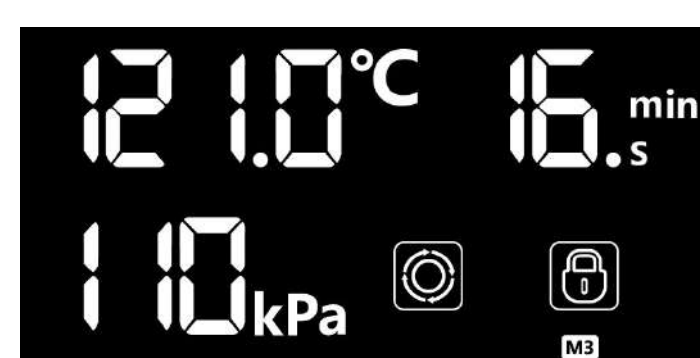

QUICK S



PROTECT B



PROTEIN B



BID TEST MODE



HELIX TEST MODE

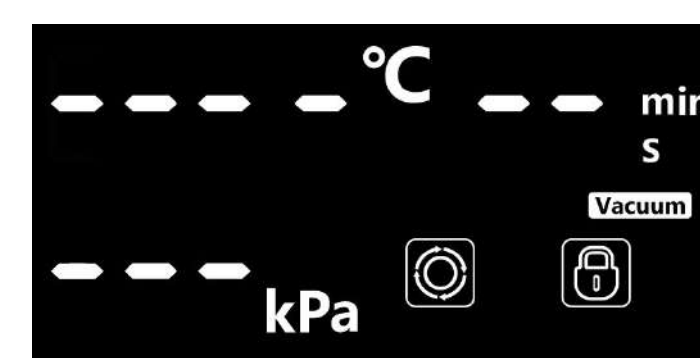

VACUUM TEST MODE

- LED zaslon na dodir omogućuje kontinuirano praćenje sterilizacije
- Kompletna sterilizacija unutar 25 min. u BRZOM programu



### E-SANIT 18

2.730,00 € + PDV

CIJENA S UKLJUČENIM PDV-OM  
**3.412,05 €**

### E-SANIT 23

2.975,00 € + PDV

CIJENA S UKLJUČENIM PDV-OM  
**3.718,75 €**

## HELIOS 500 INTRAORALNI SKENER

Jedan od najpreciznijih i najlakših skenera na tržištu sa odstupanjem do 20.0  $\mu$ m i **težinom od samo 185 grama**

Gumb za prebacivanje između gornje i doljne čeljusti i zagriža



Senzori posložaja za bolju interakcijsku sa pacijentom

- Skeniranje punog luka u manje od 30 sekundi
- Automatska kalibracija
- AI tehnologija filtrira meka i pokretna tkiva te omogućava korisniku glatko skeniranje
- Datoteke u STL/PLY formatu
- Skener je otvorenog tipa sa besplatnom licencom, softverskim nadogradnjama i virtualnom memorijom



6.500,00 € + PDV

CIJENA S UKLJUČENIM PDV-OM

**8.125,00 €**

# EIGHTEETH ULTRAMINT PRO

## ULTRASONIC SCALER

**Eighteeth ima širok asortiman nastavaka za konzervativu, parodontologiju i endodonciju** koje je moguće posebno naručiti tako da su Vam dostupni scaleri za razne indikacije.

U pakiranju se nalazi i autoklavabilna plastična kutija za handpiece i 6 scalera. Sam handpiece je ergonomskog oblika, ima LED svjetlo te se putem njega regulira protok vode, lako se uklanja i sterilizira kako bi se izbjegla kontaminacija.

**Display ima SmartTouch system**, osjetljiv na dodir te je i vodootporan. Kadica je zapremnine 900 ml i na sebi ima gumb za regulaciju protoka vode.

**Uređaj radi na širokom spektru frekvencija**, od 25kHz do 42kHz – digitalno je kontroliran, čime je osigurano da uređaj radi na optimalnoj frekvenciji.



624,00 € + PDV

CIJENA S UKLJUČENIM PDV-OM  
780,00 €



### EMS G1 SATELEC G1-S

Function Description: All-round removal of supragingival calculus

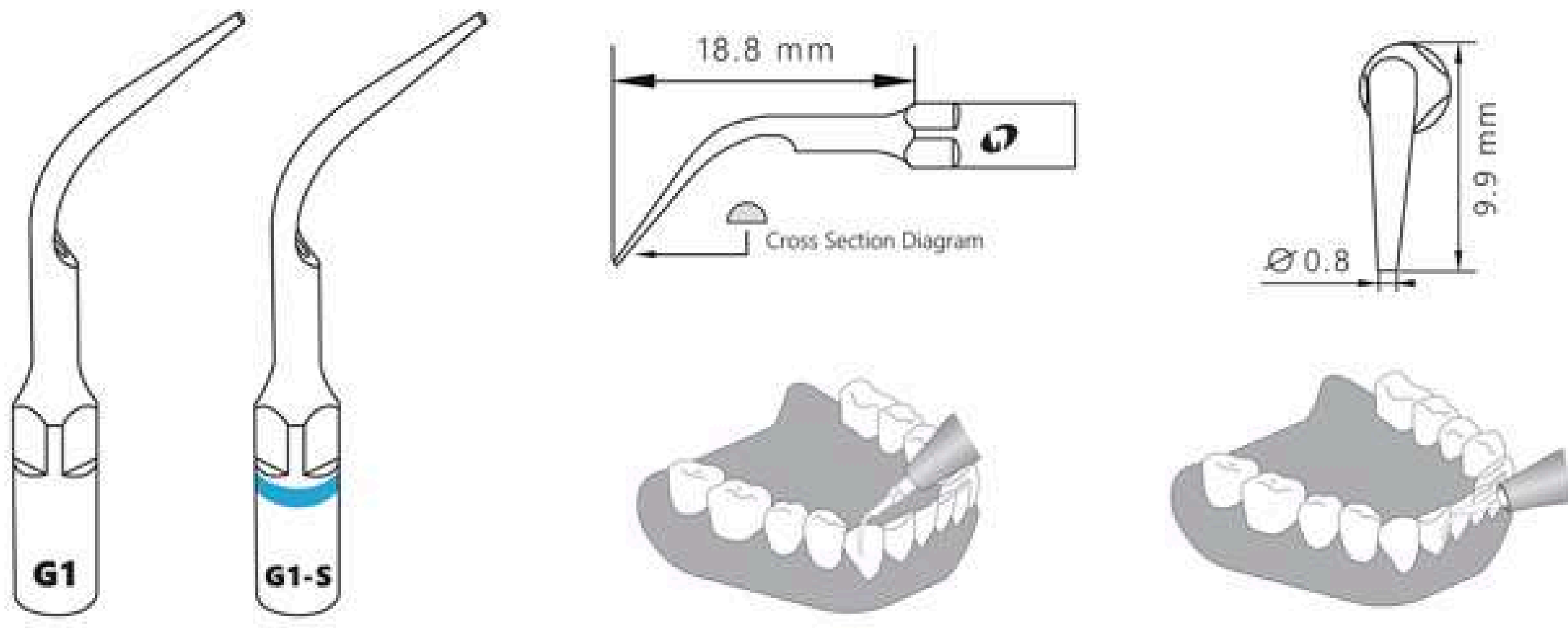

### EMS P1 SATELEC P1-S

Function Description: Removal of subgingival calculus and periodontal irrigation

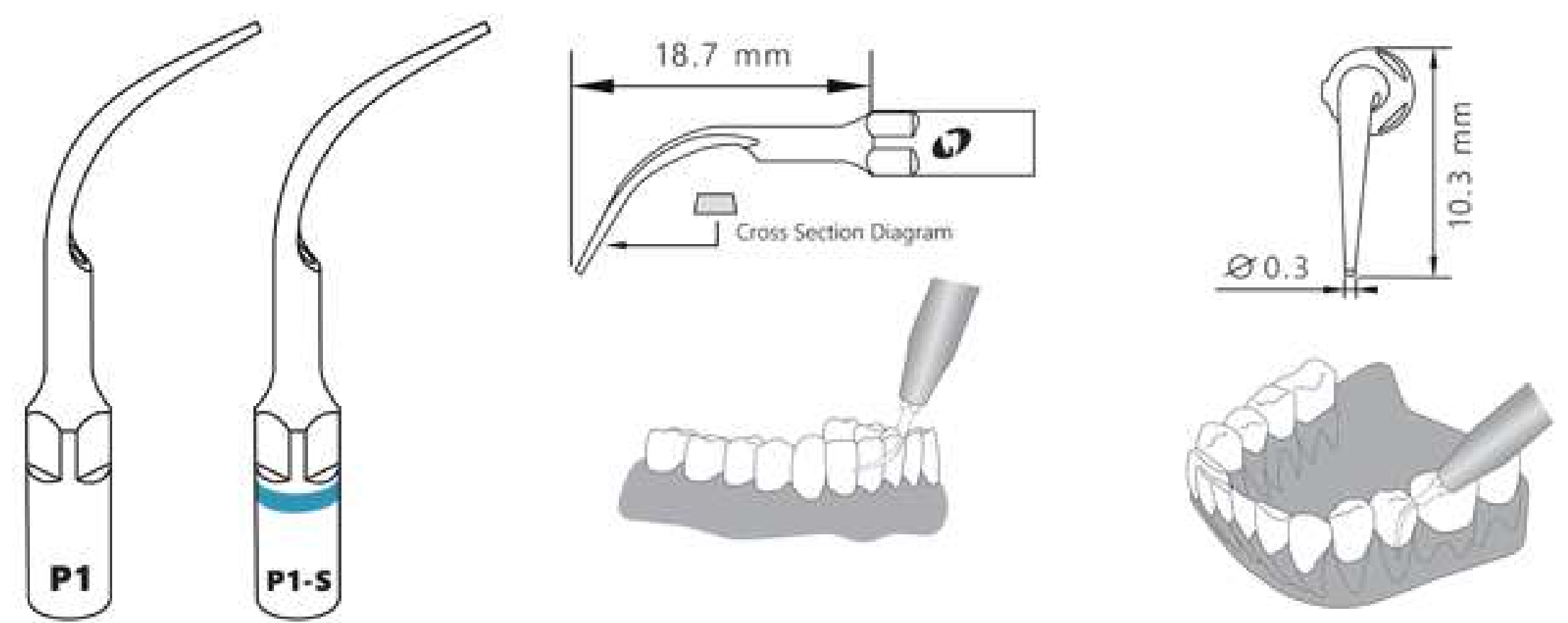

### EMS G2 SATELEC G2-S

Function Description: Removal of significant supragingival calculus

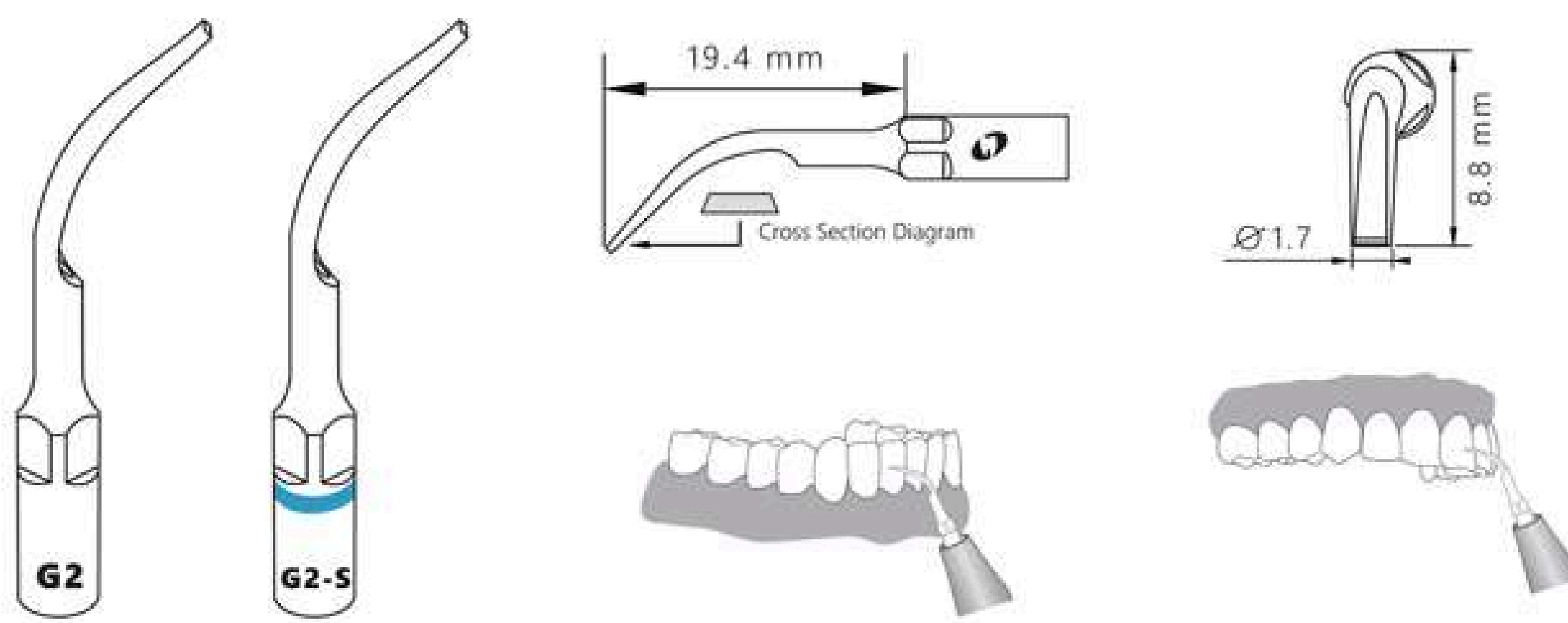

### EMS P3 SATELEC P3-S

Function Description: Removal of calculus deep in periodontal pocket and its irrigation

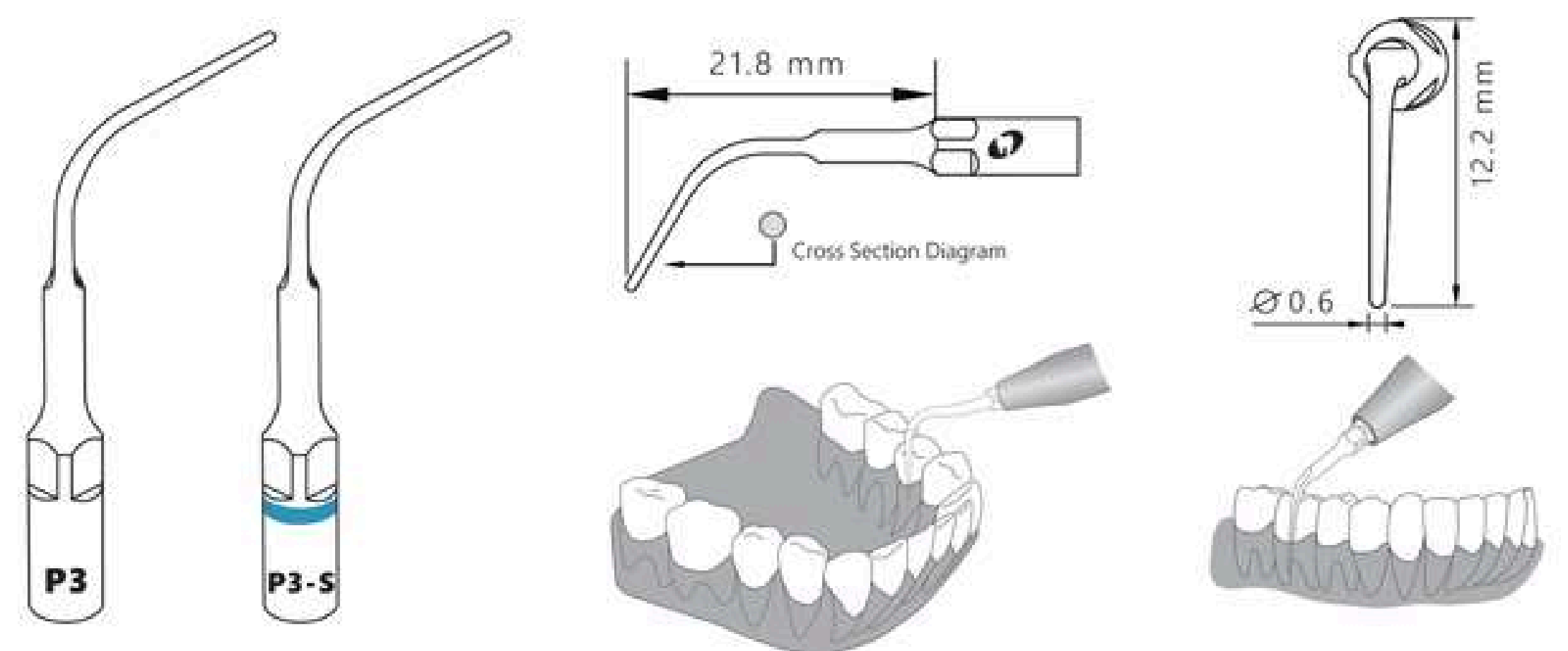

### EMS G4 SATELEC G4-S

Function Description: Used for supragingival and interdental space scaling

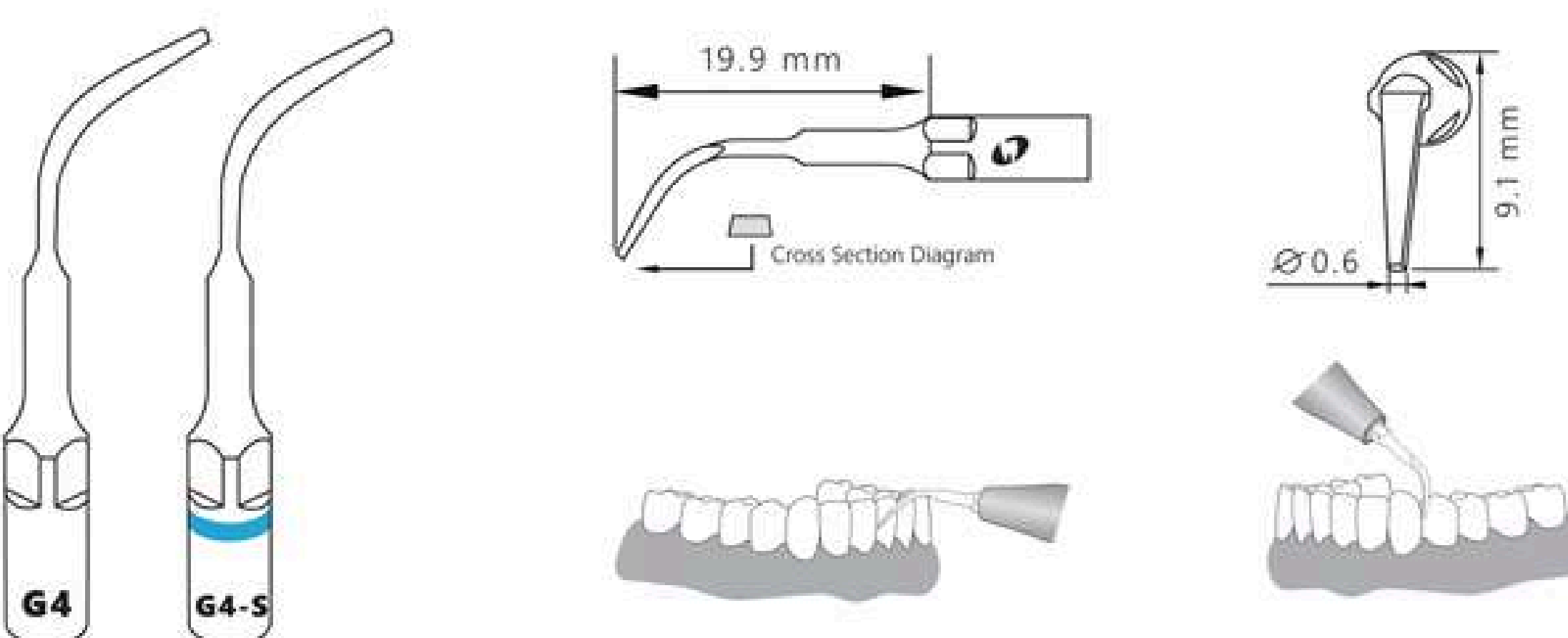

### EMS P4 SATELEC P4-S

Function Description: Removal of calculus in shallow pockets

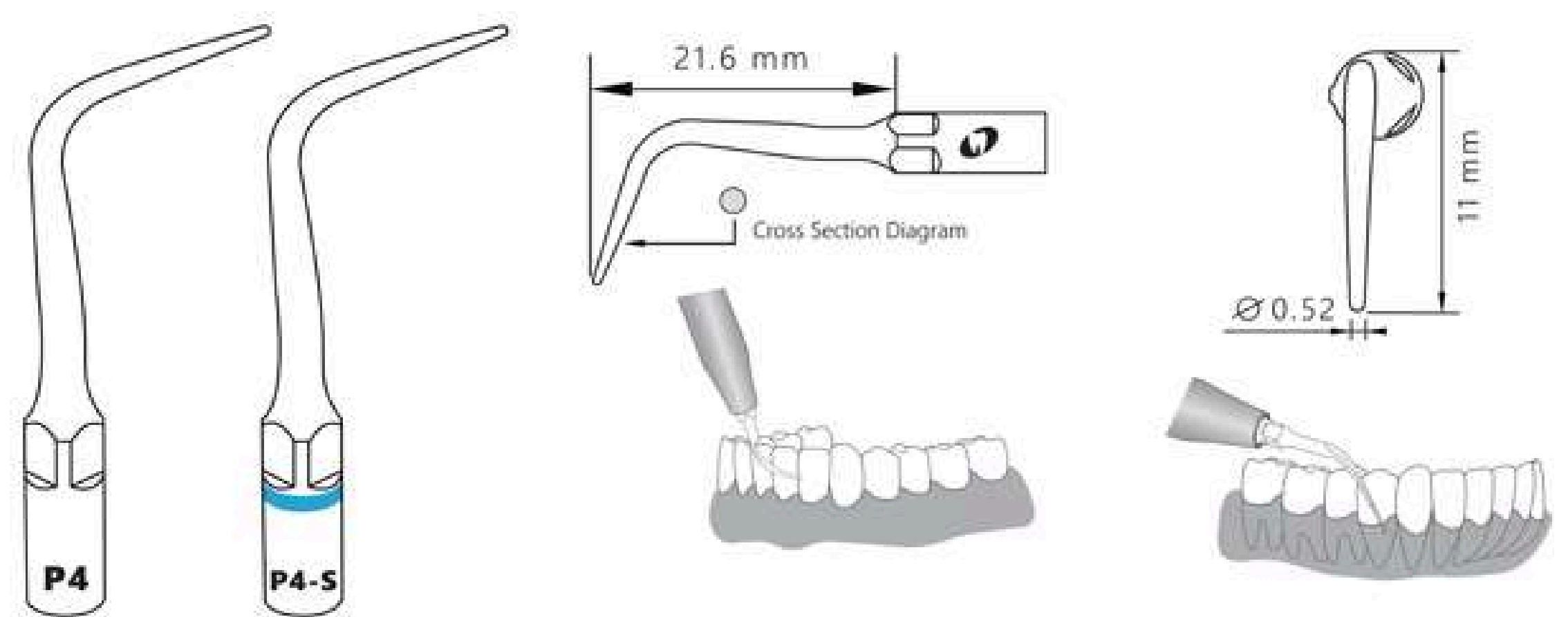

### EMS G5 SATELEC G5-S

Function Description: Removal of significant supragingival calculus

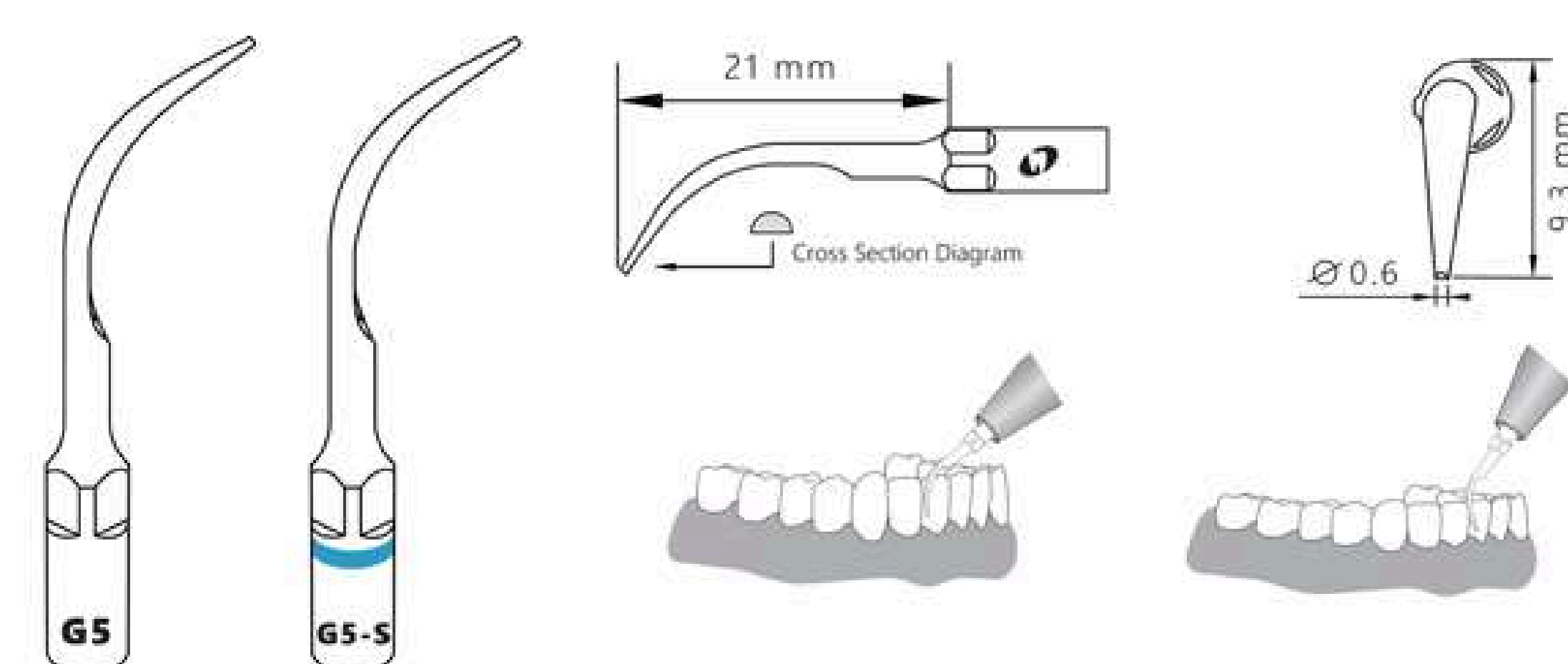

### EMS P52 SATELEC P52-S

Function Description: Supragingival scaling

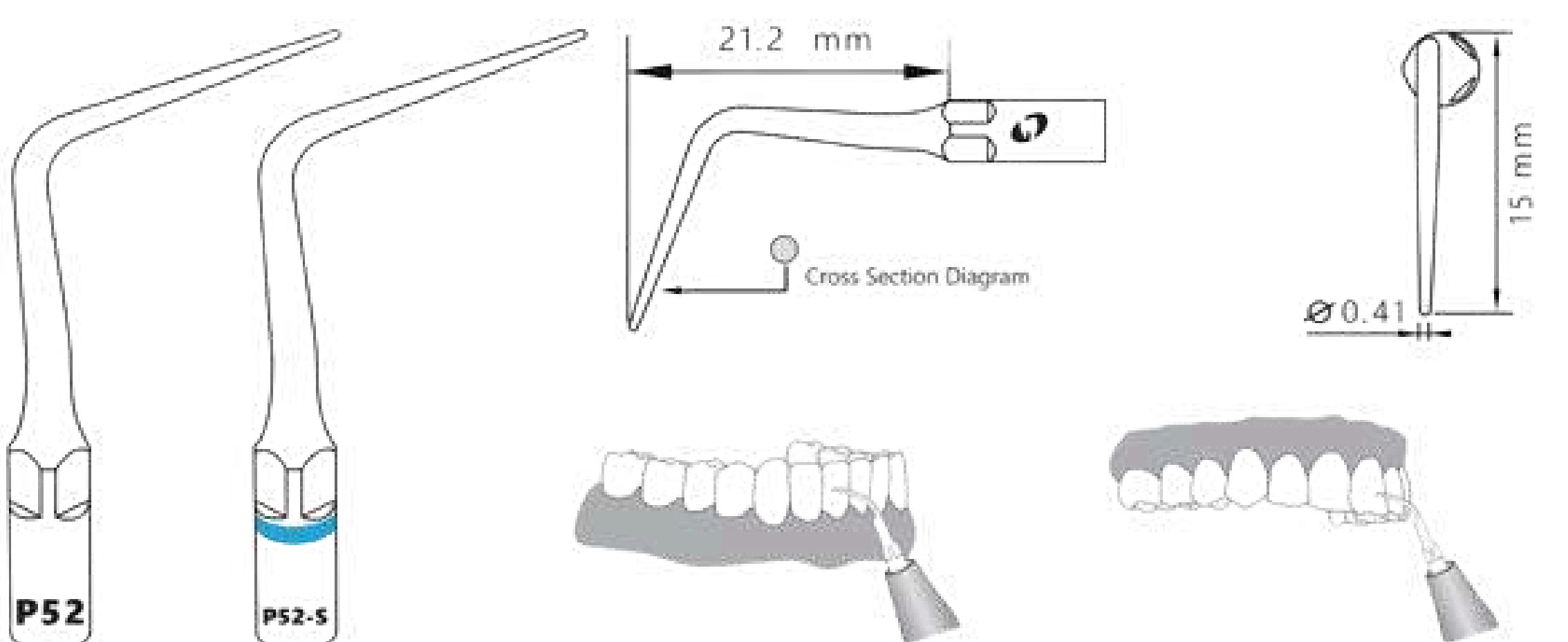

31,00€ + PDV

38,75€

24,80€ + PDV

31,00€

CIJENA S UKLJUČENIM PDV-OM

-20%

**EMS P50L SATELEC P50L-S**

Function Description: Used for subgingival calculus probing, subgingival proximal surface scaling and root planing

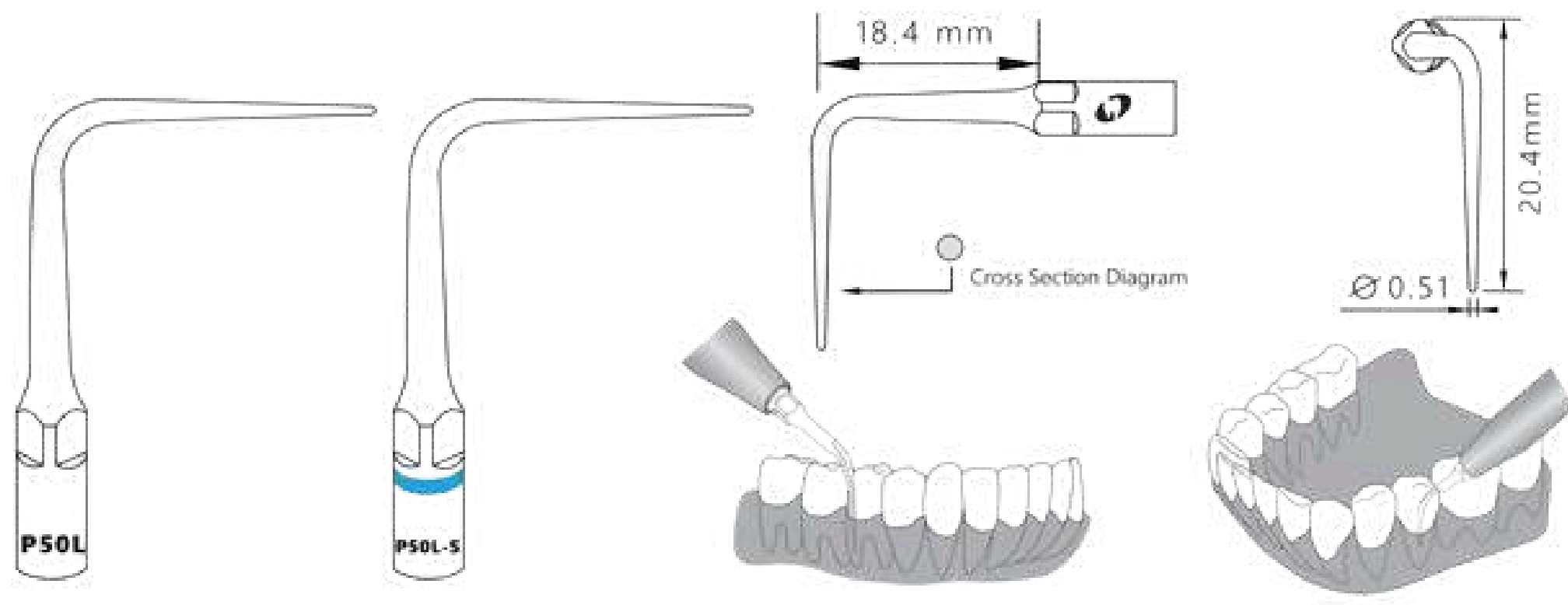

**EMS P50R SATELEC P50R-S**

Function Description: Used for subgingival calculus probing, subgingival proximal surface scaling and root planing

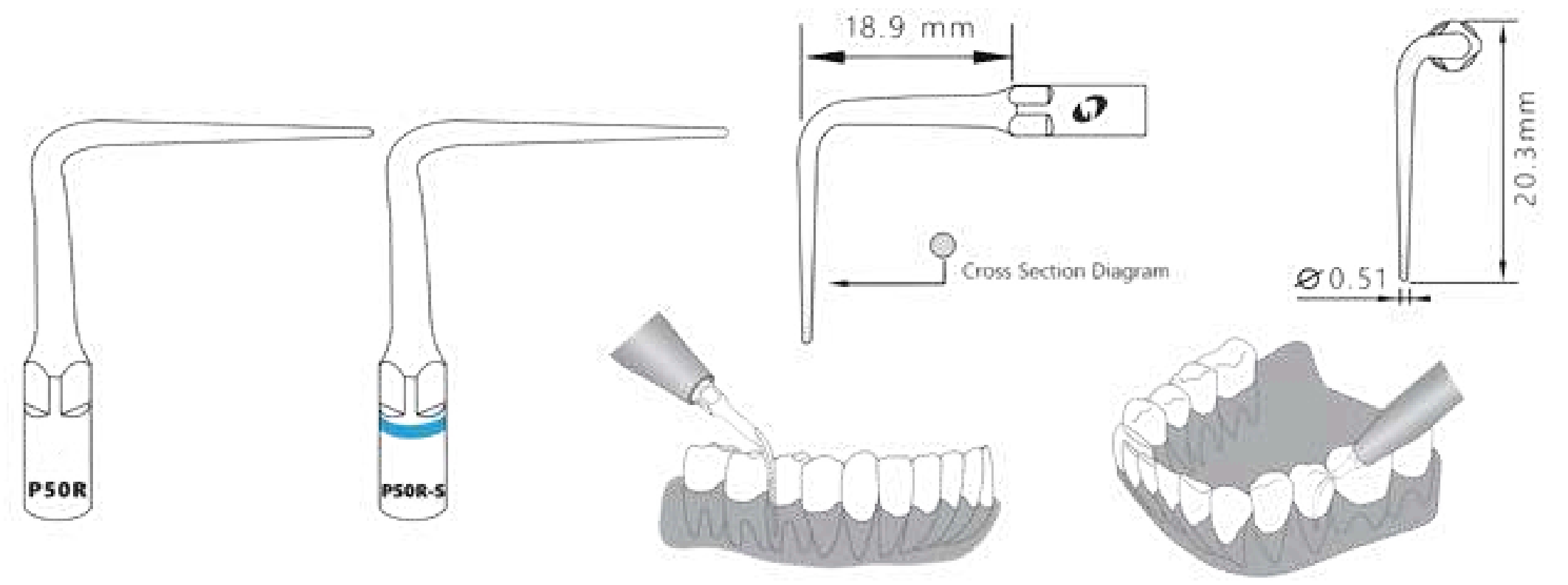

**EMS P53L SATELEC P53L-S**

Function Description: Used for subgingival calculus probing, subgingival proximal surface scaling and root planing

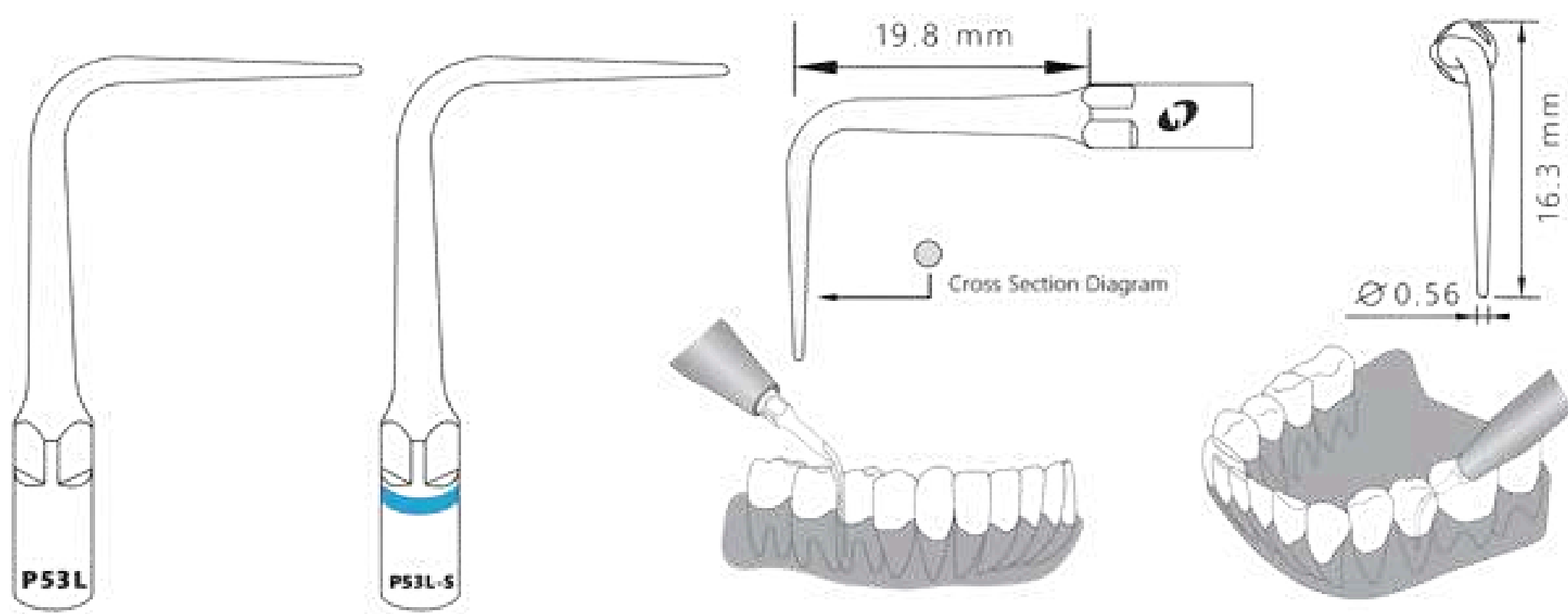

**EMS P53R SATELEC P53R-S**

Function Description: Used for subgingival calculus probing, subgingival proximal surface scaling and root planing

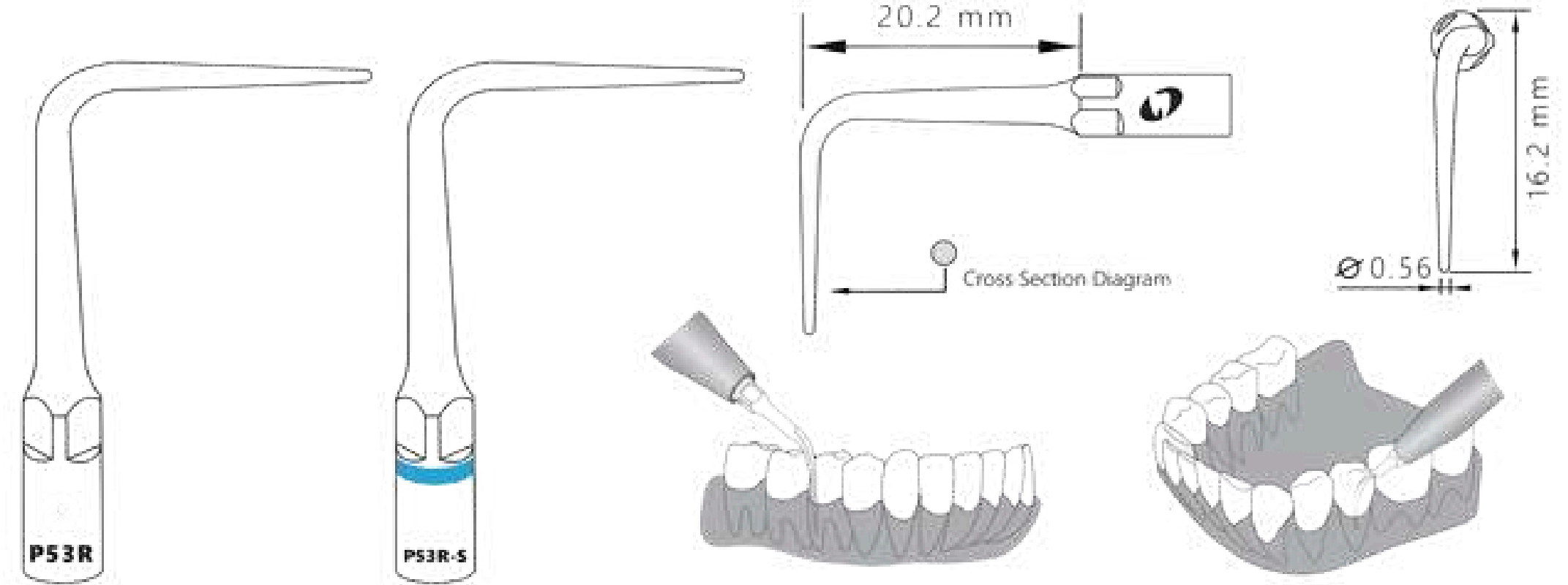

**EMS P59 SATELEC P59-S**

Function Description: Used for subgingival calculus probing and scaling

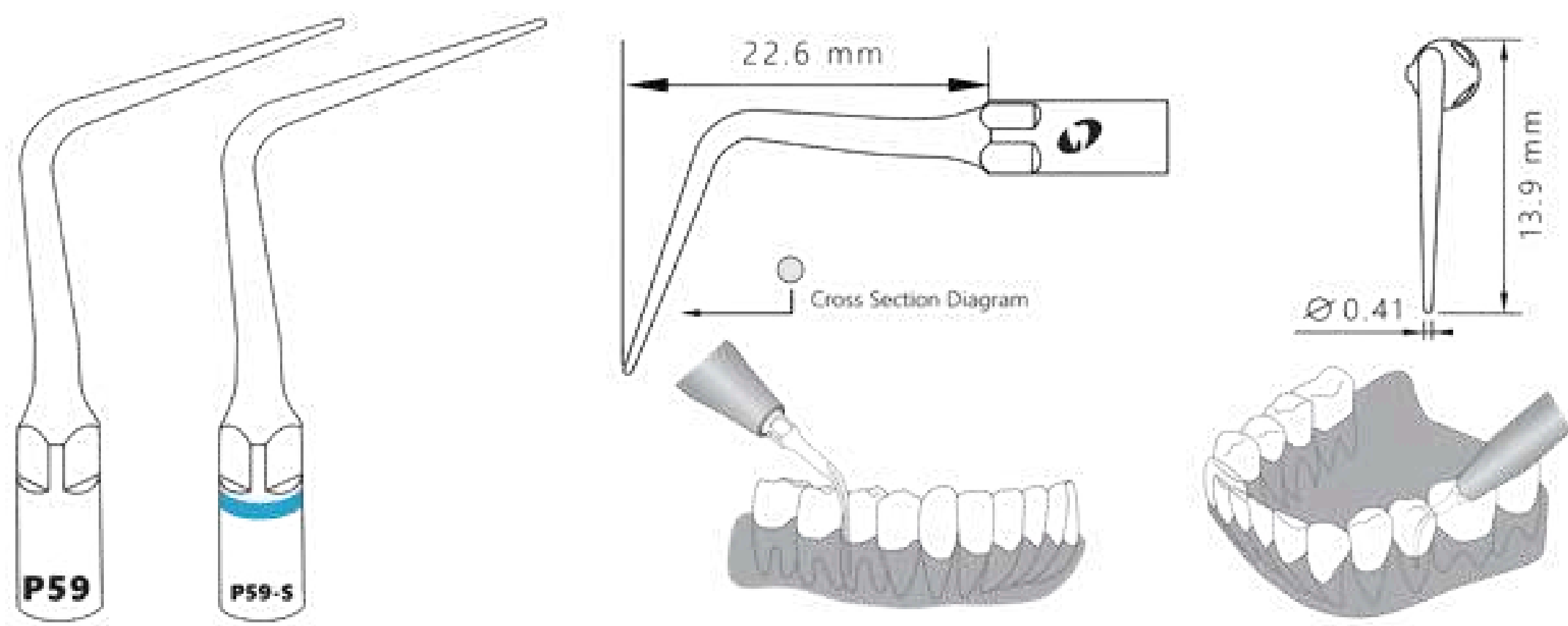

**EMS P56 SATELEC P56-S**

Function Description: Removal of significant supragingival calculus and plaque

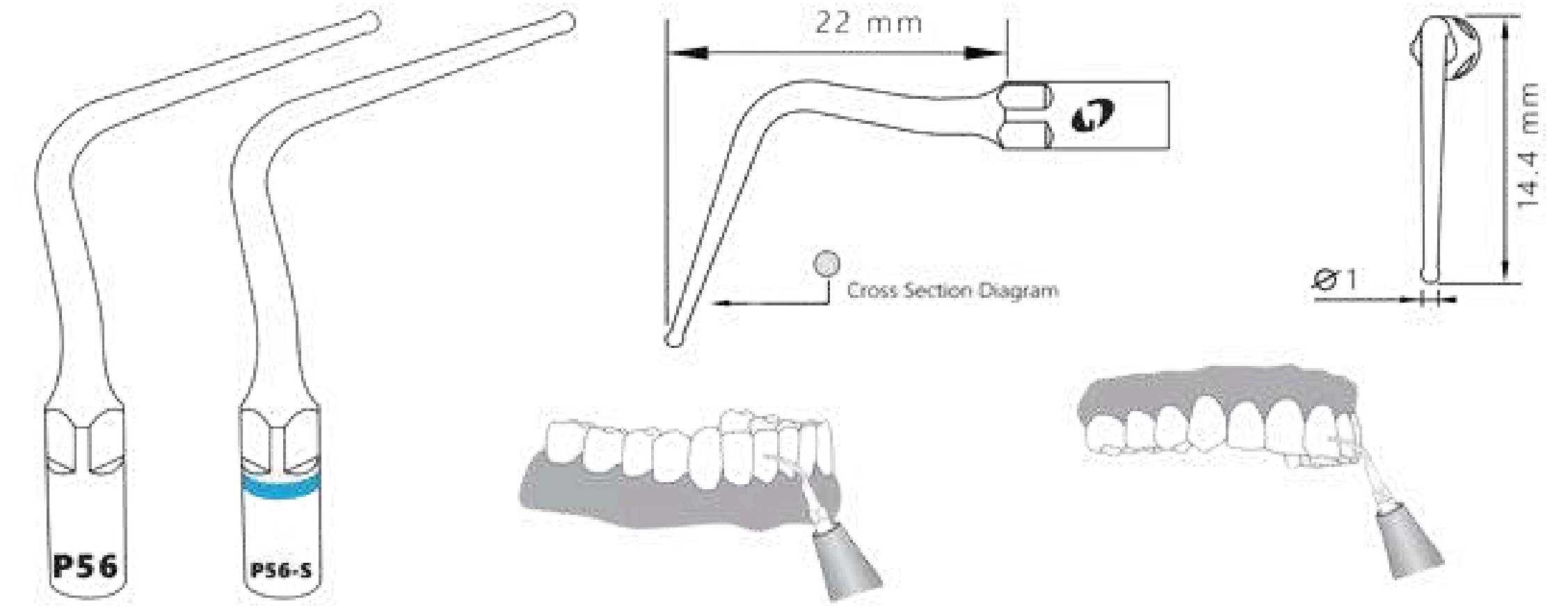

**EMS P3D SATELEC P3D-S**

Function Description: Used to level off the surface of endo after the periodontal flap surgery

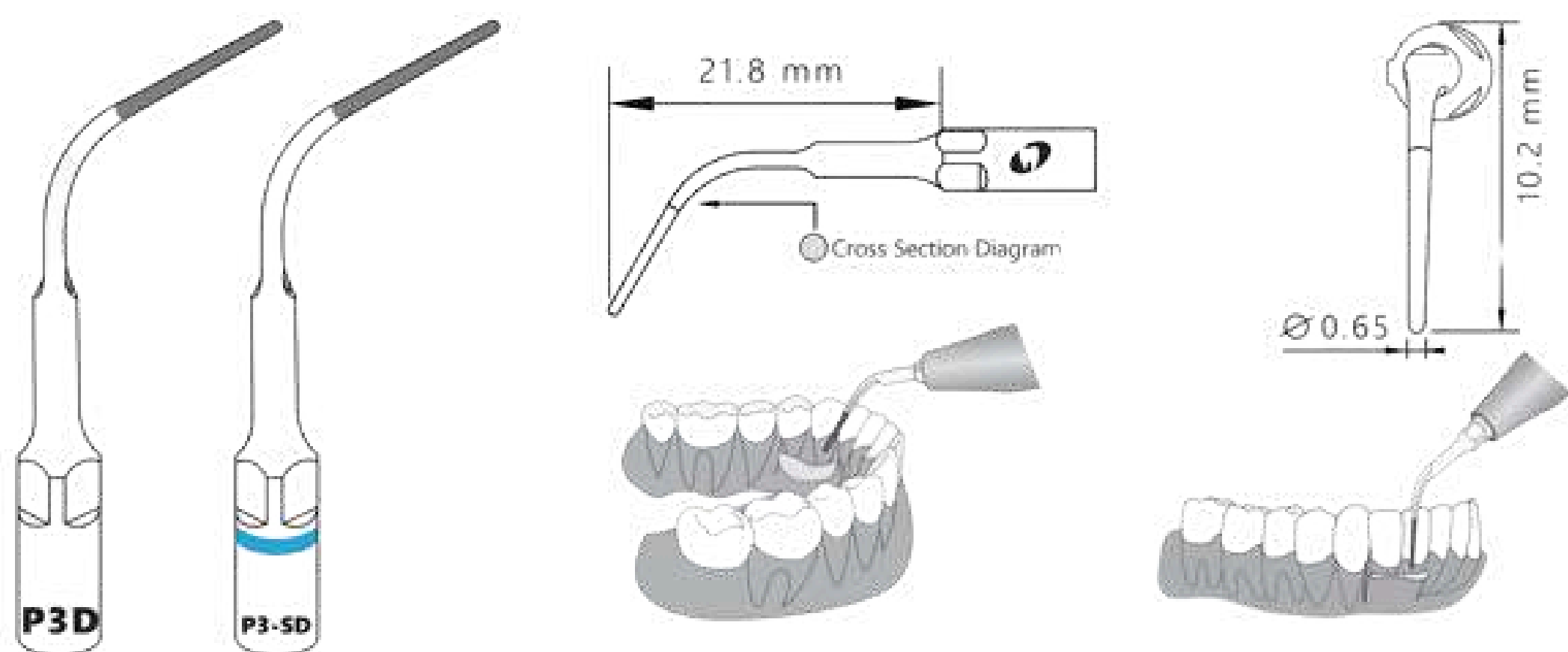

**EMS P4D SATELEC P4D-S**

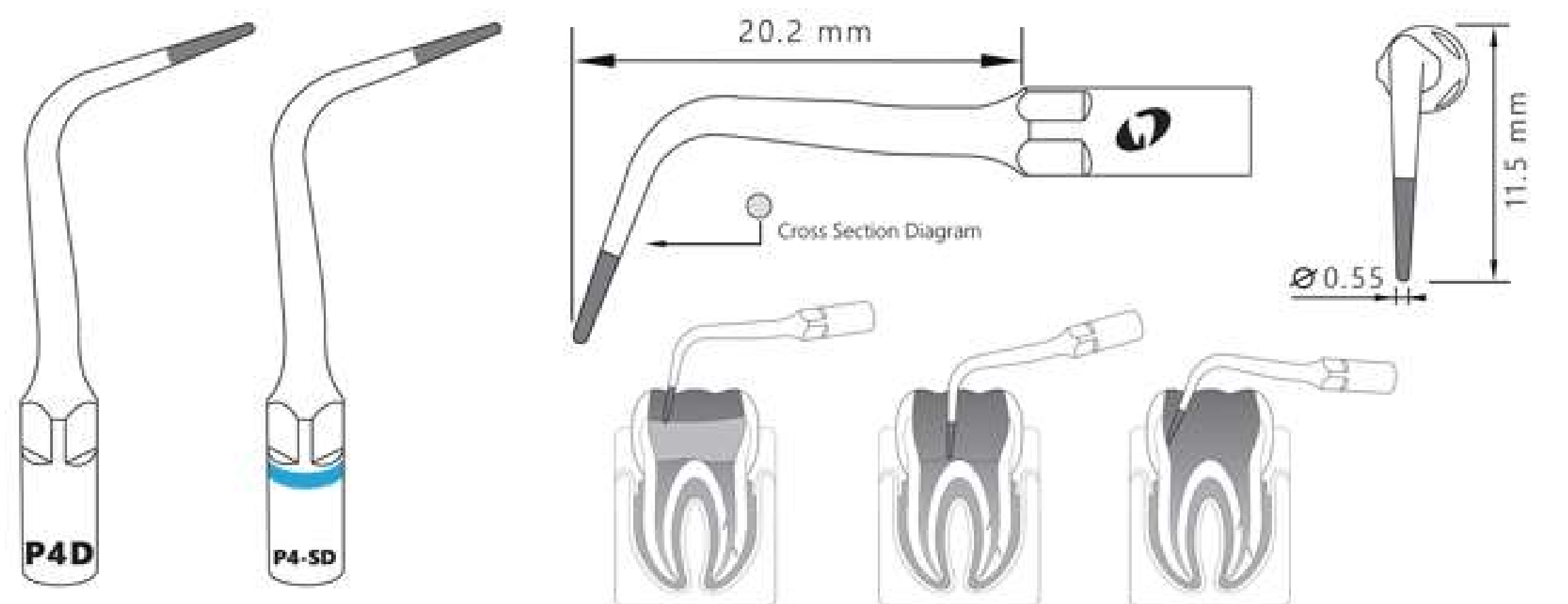

31,00€ + PDV

38,75€

24,80€ + PDV

31,00€

CIJENA S UKLJUČENIM PDV-OM

-20%

### EMS E1 SATELEC E1-S

Function Description: 120° angle holder for 0.7mm-0.8mm endo file for root canal cleaning

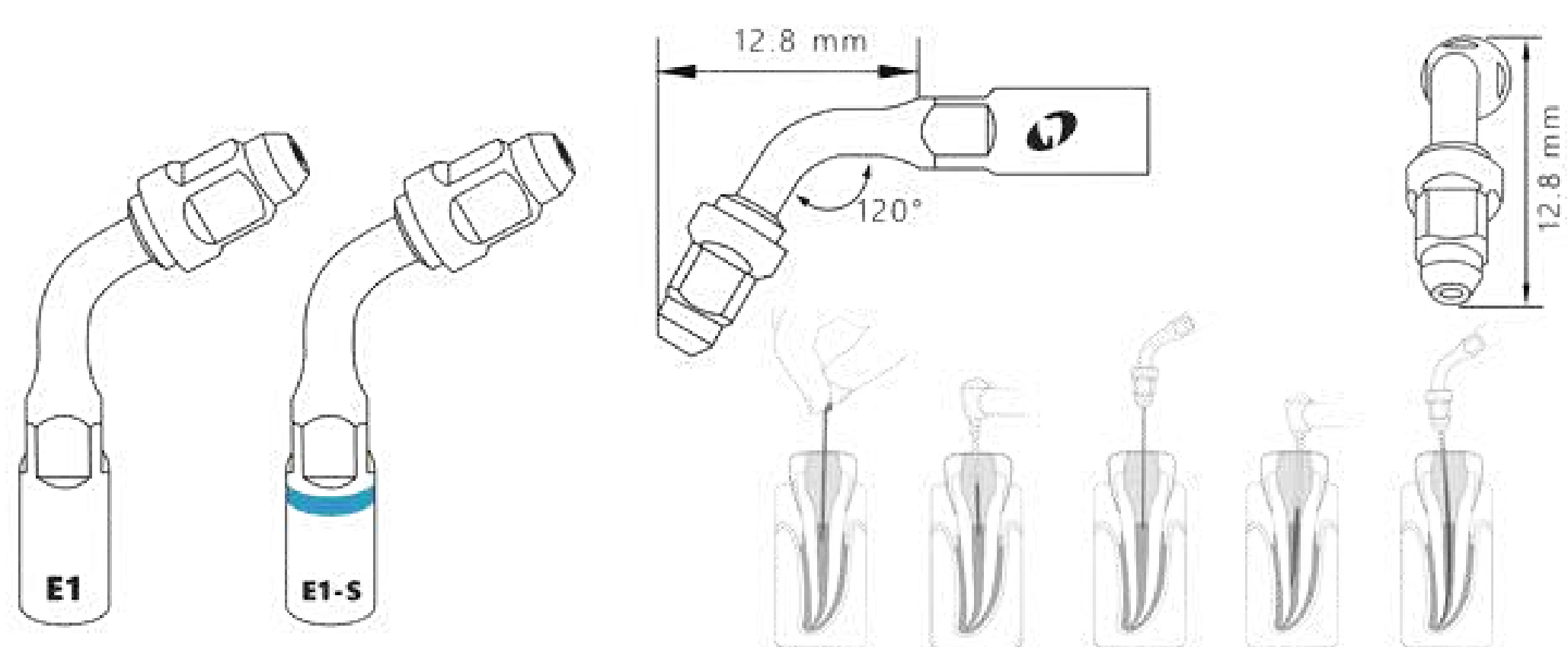

### EMS E3 SATELEC E3-S

Function Description: For lateral condensation of gutta percha by heating effect

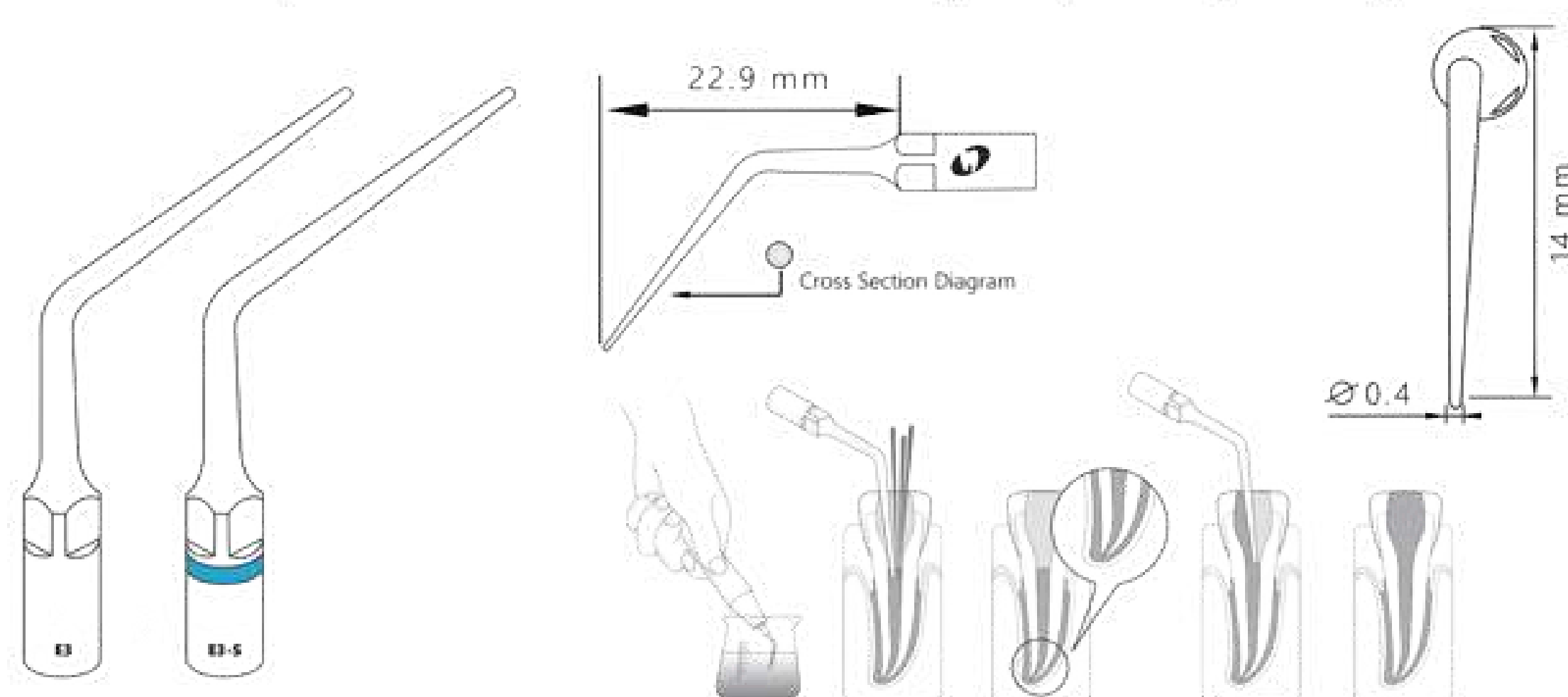

### EMS E4 SATELEC E4-S

Function Description: Removal of foreign filling material during re-treatment

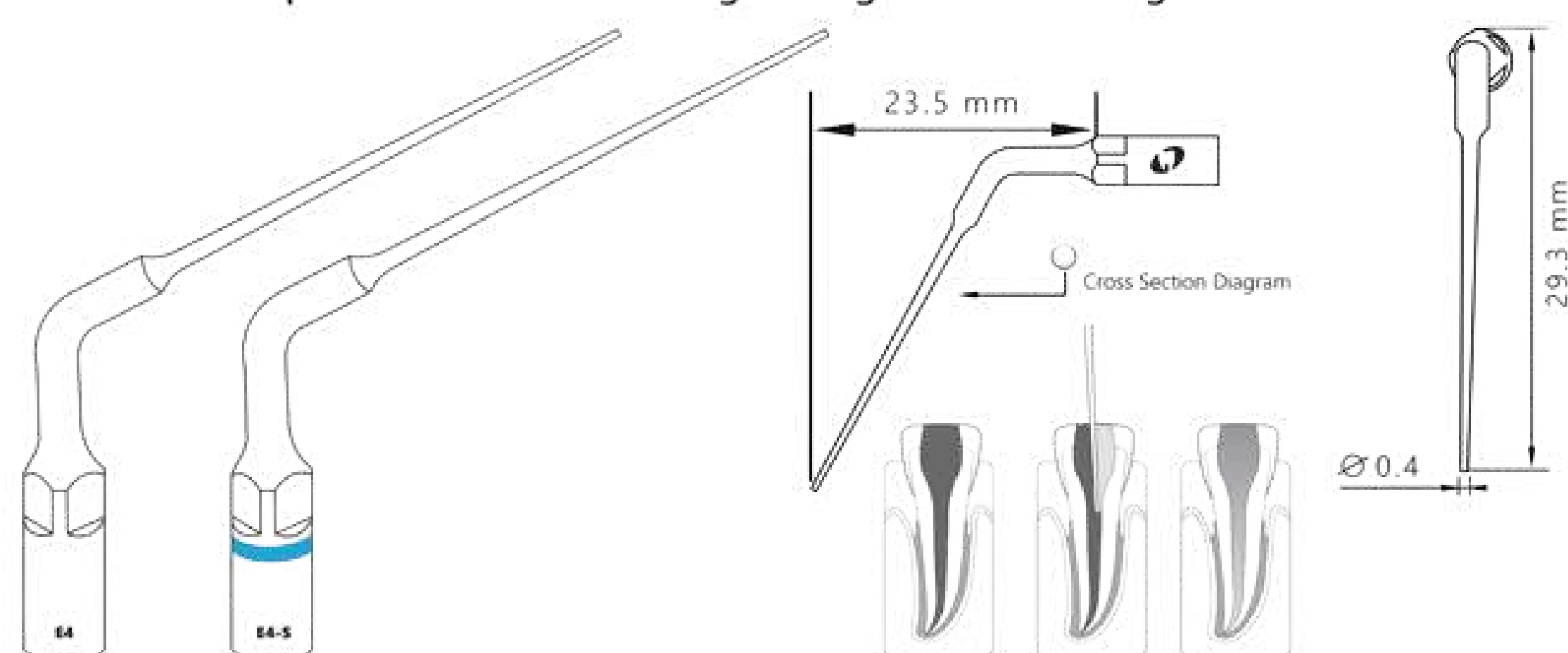

### EMS E5 SATELEC E5-S

Function Description: Removal of foreign filling material during re-treatment

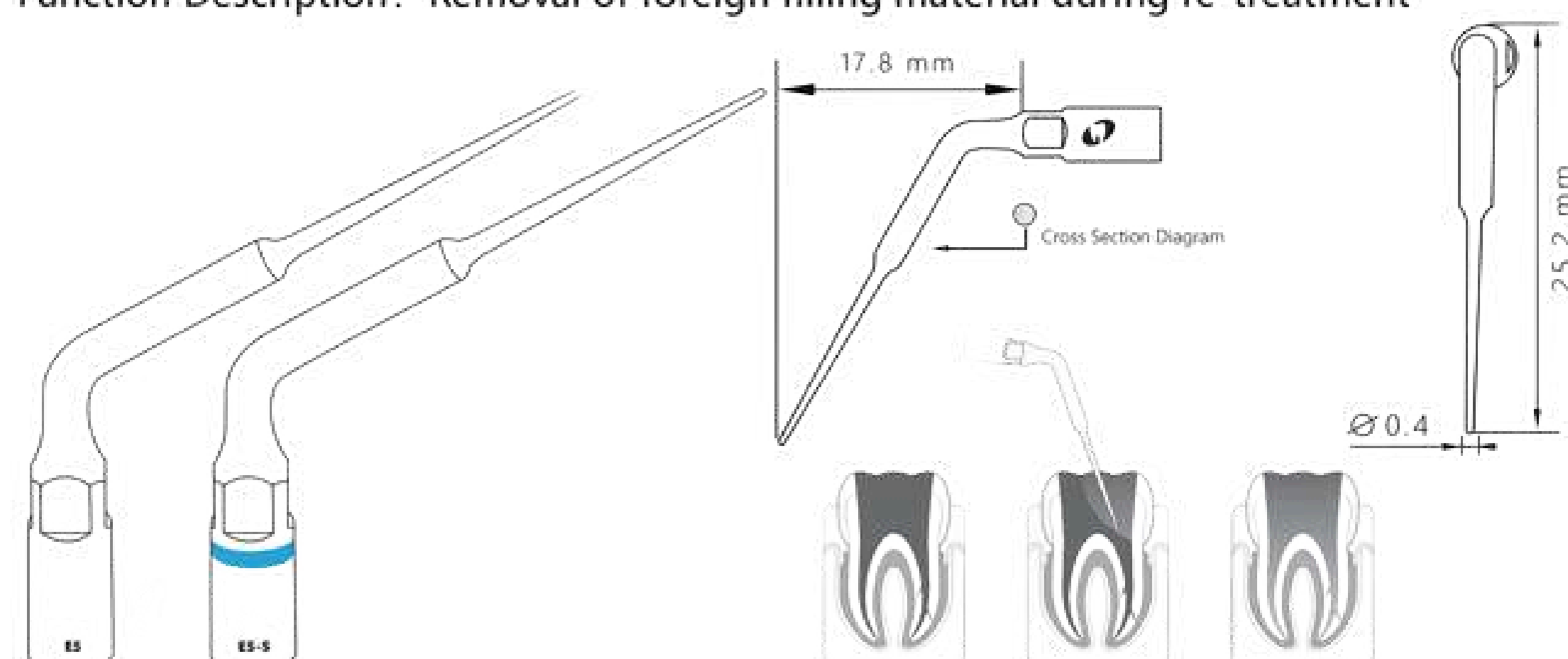

### EMS E7 SATELEC E7-S

Function Description: Removal of broken instrument

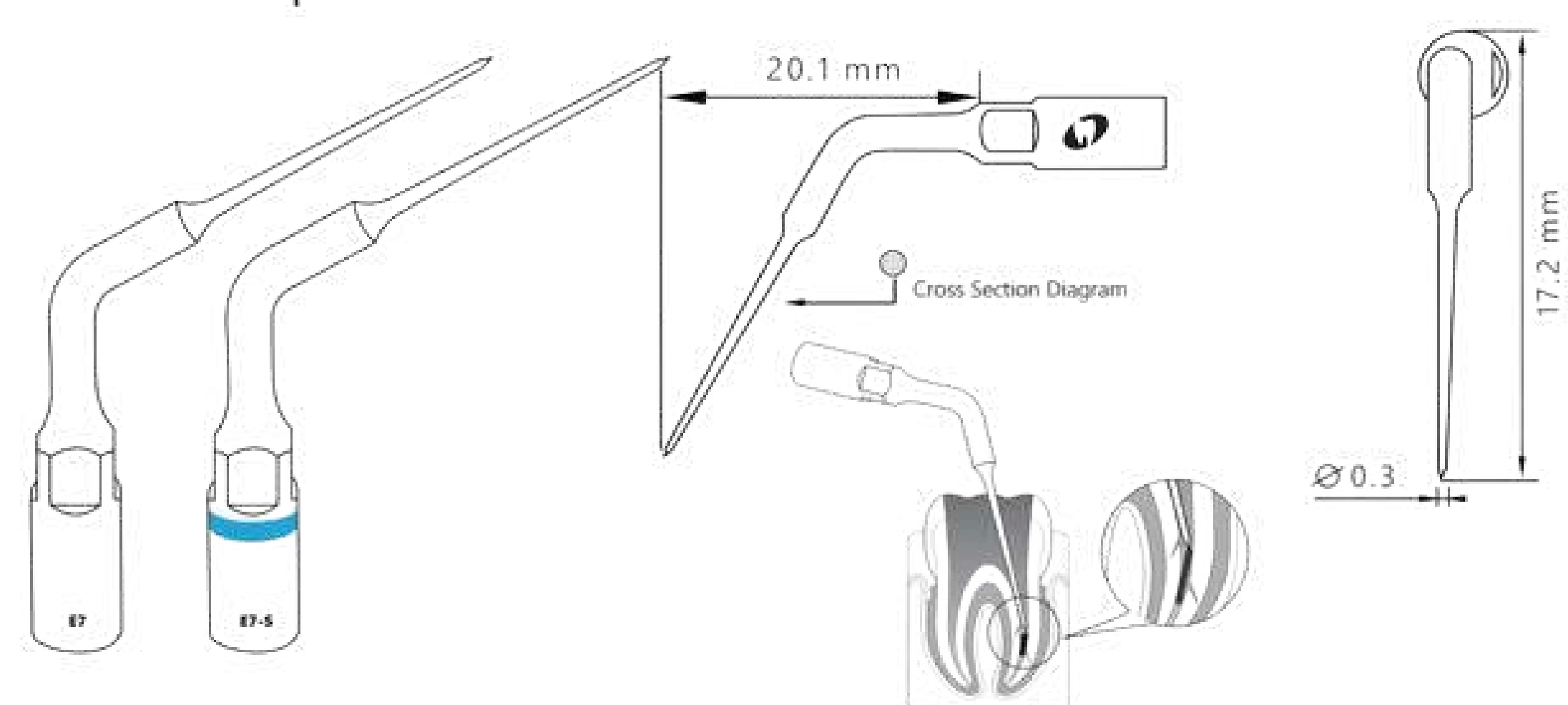

### EMS E8 SATELEC E8-S

Function Description: Used to brush the canal walls during re-treatment

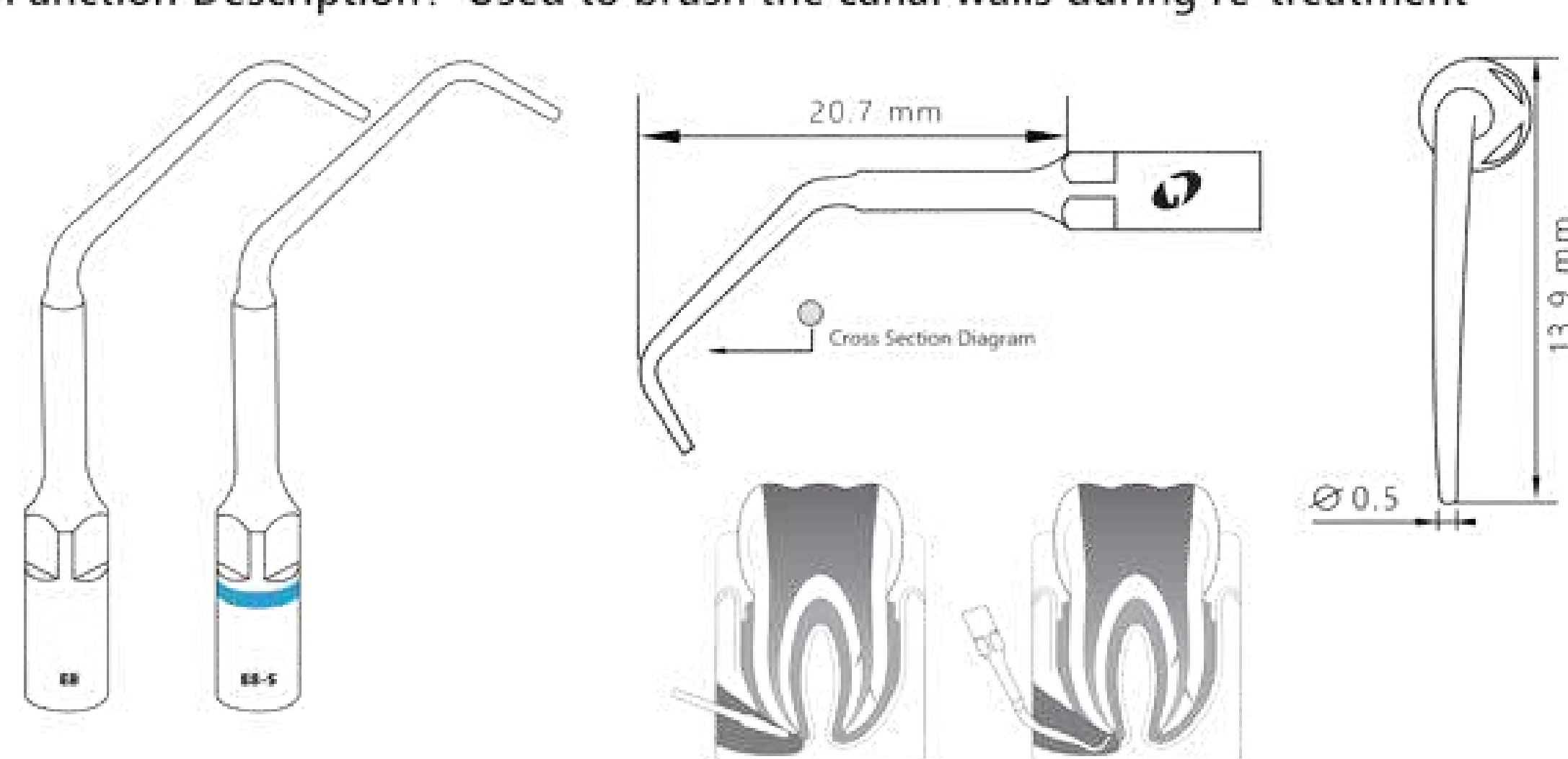

### EMS E9 SATELEC E9-S

Function Description: Flexible, used for irrigation

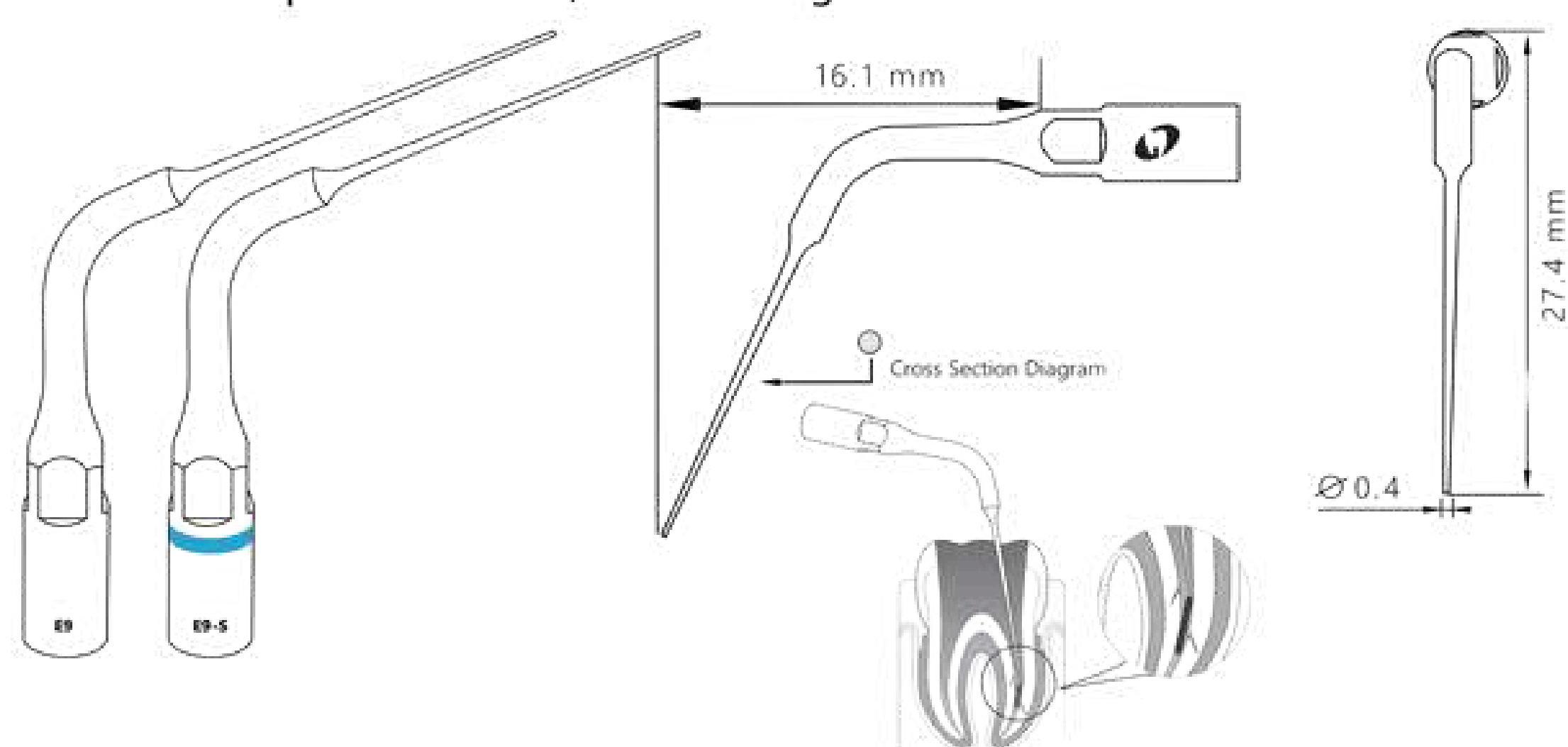

### EMS E30 SATELEC E30-S

Function Description: Removal of deep foreign particles in canal

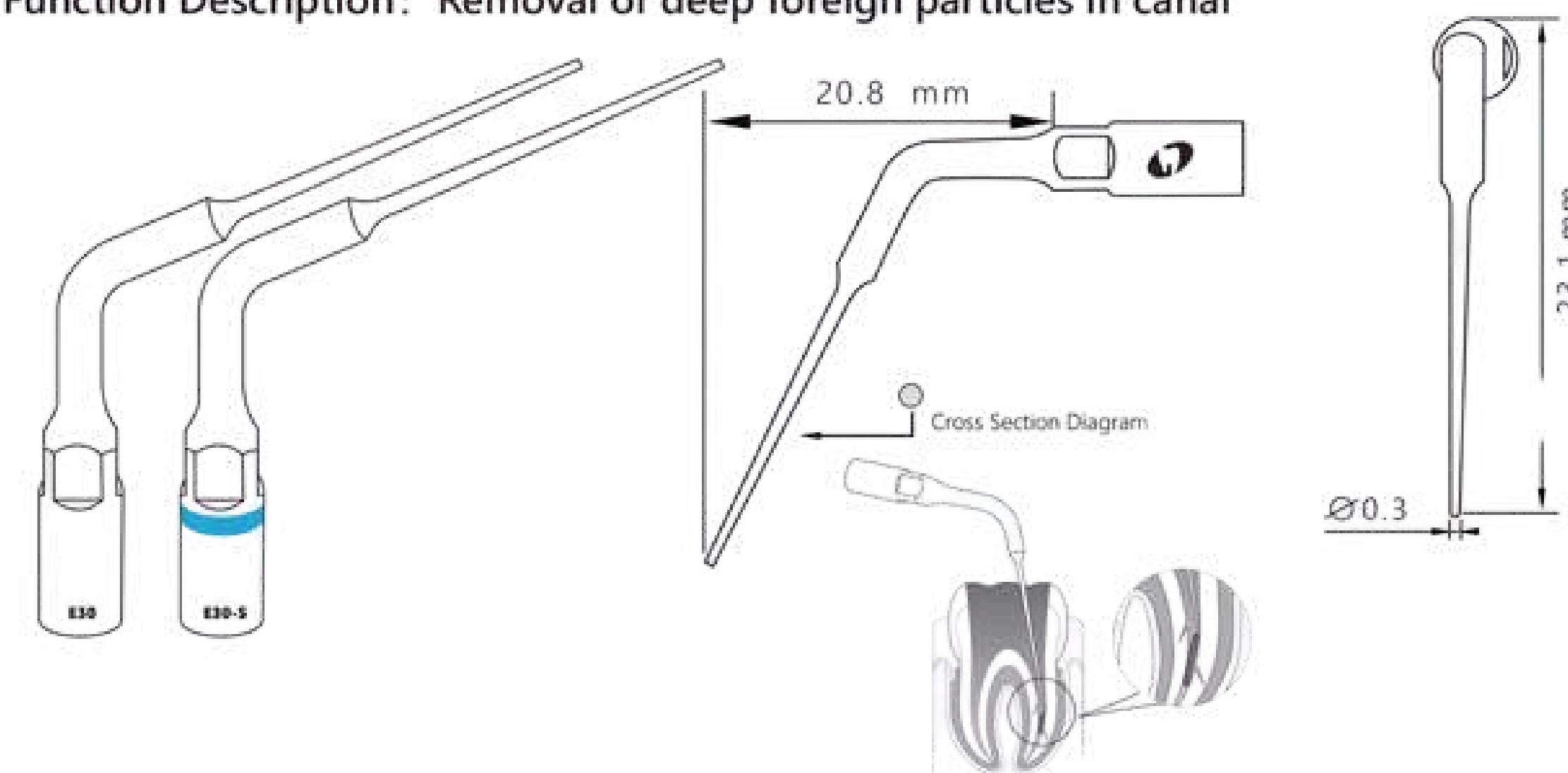

31,00€ + PDV

38,75€

24,80€ + PDV

31,00€

CIJENA S UKLJUČENIM PDV-OM

-20%

**EMS E31 SATELEC E31-S**

Function Description: Removal of foreign particles in one-third of the canal

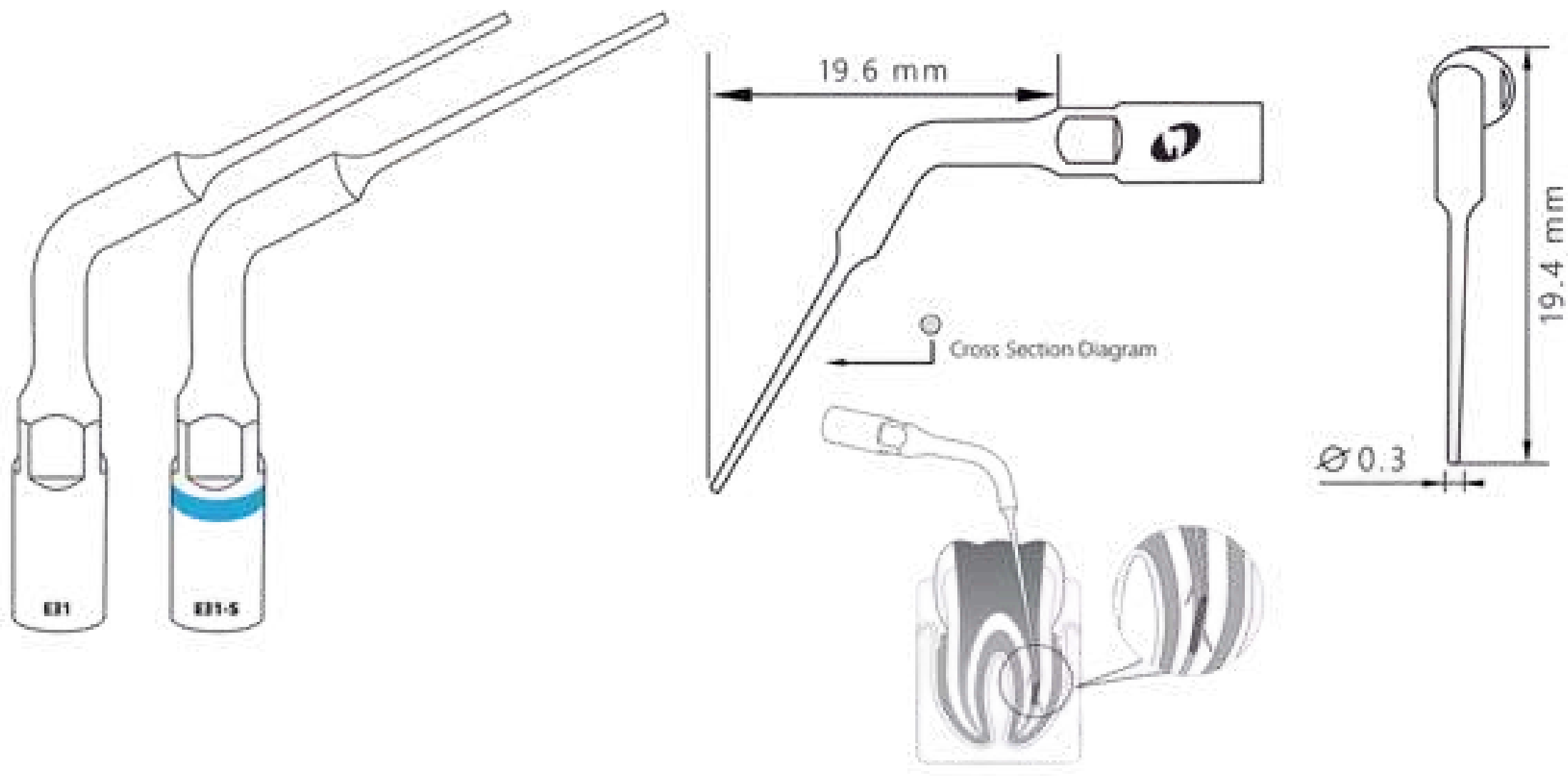

**EMS E3D SATELEC E3D-S**

Function Description: Enlargement of the canal walls to remove the broken instrument

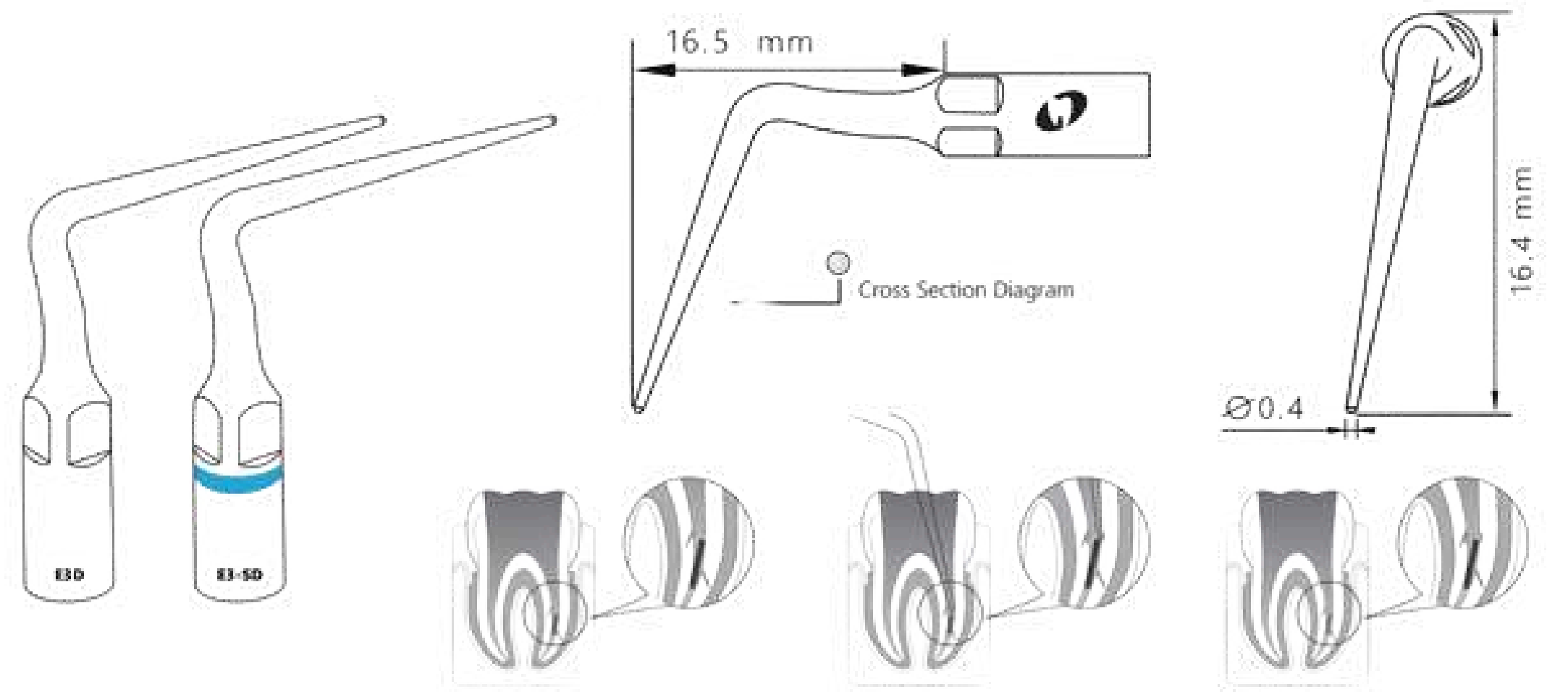

**EMS E4D SATELEC E4D-S**

Function Description: Removal of hard material in canal during re-treatment

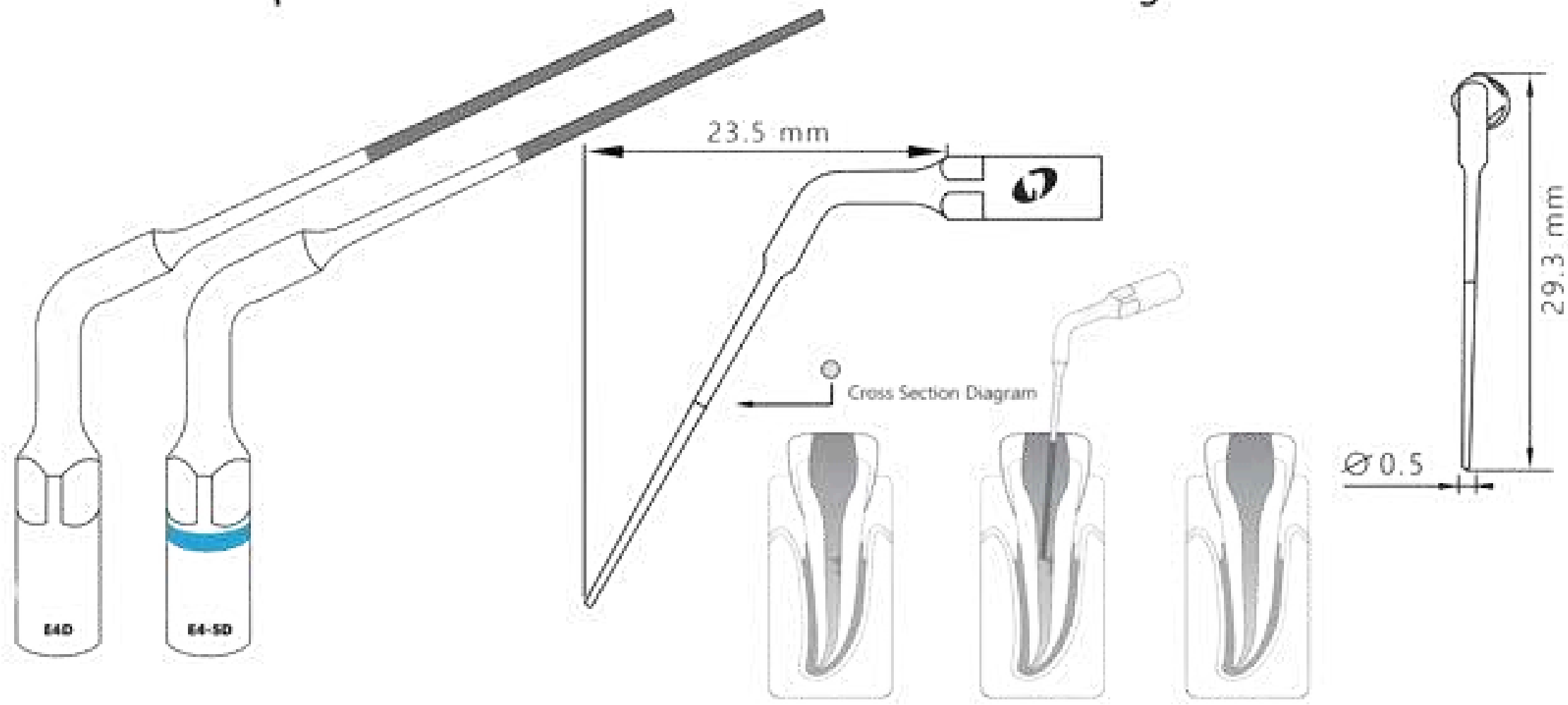

**EMS E5D SATELEC E5D-S**

Function Description: Removal of hard material in canal during re-treatment

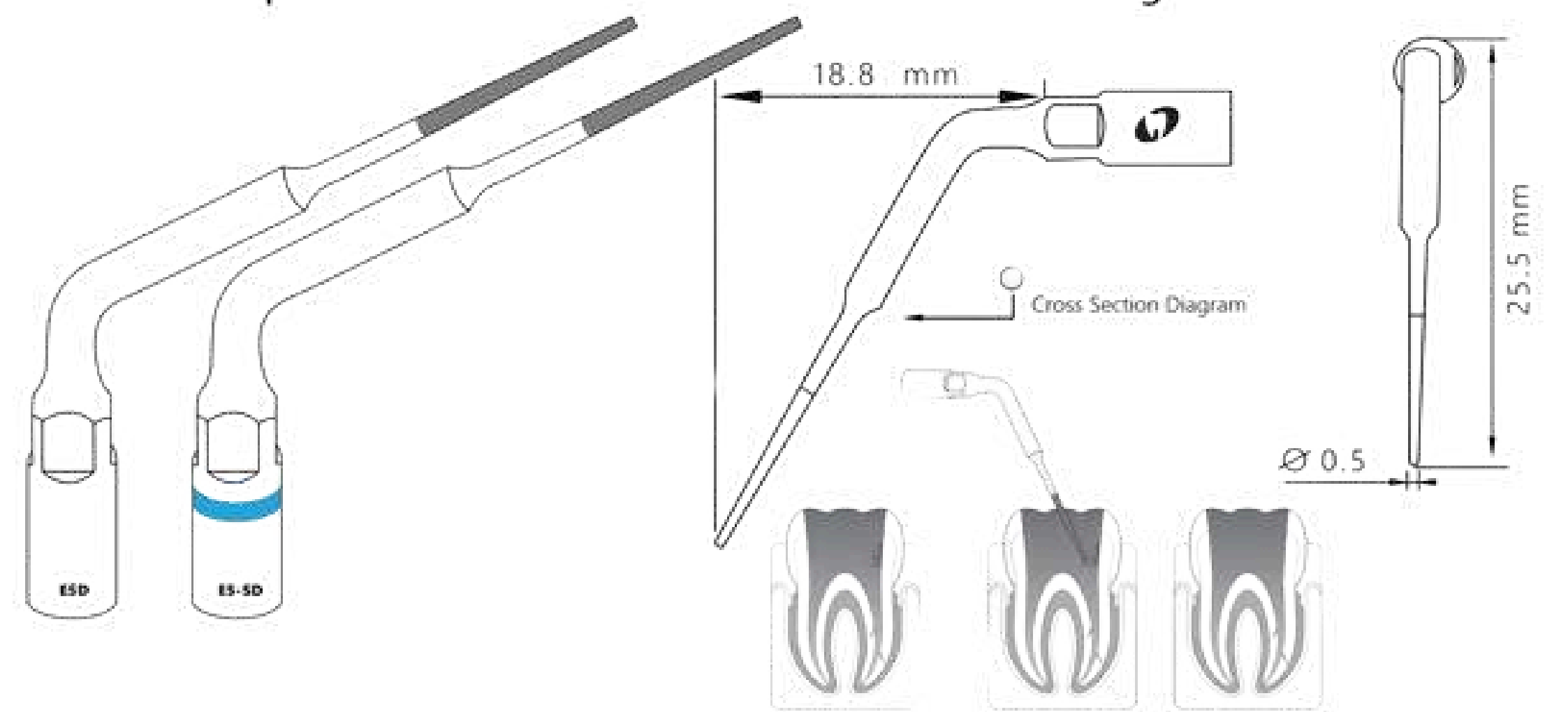

**EMS E6D SATELEC E6D-S**

Function Description: Removal of foreign material in cavity to access canal orifice

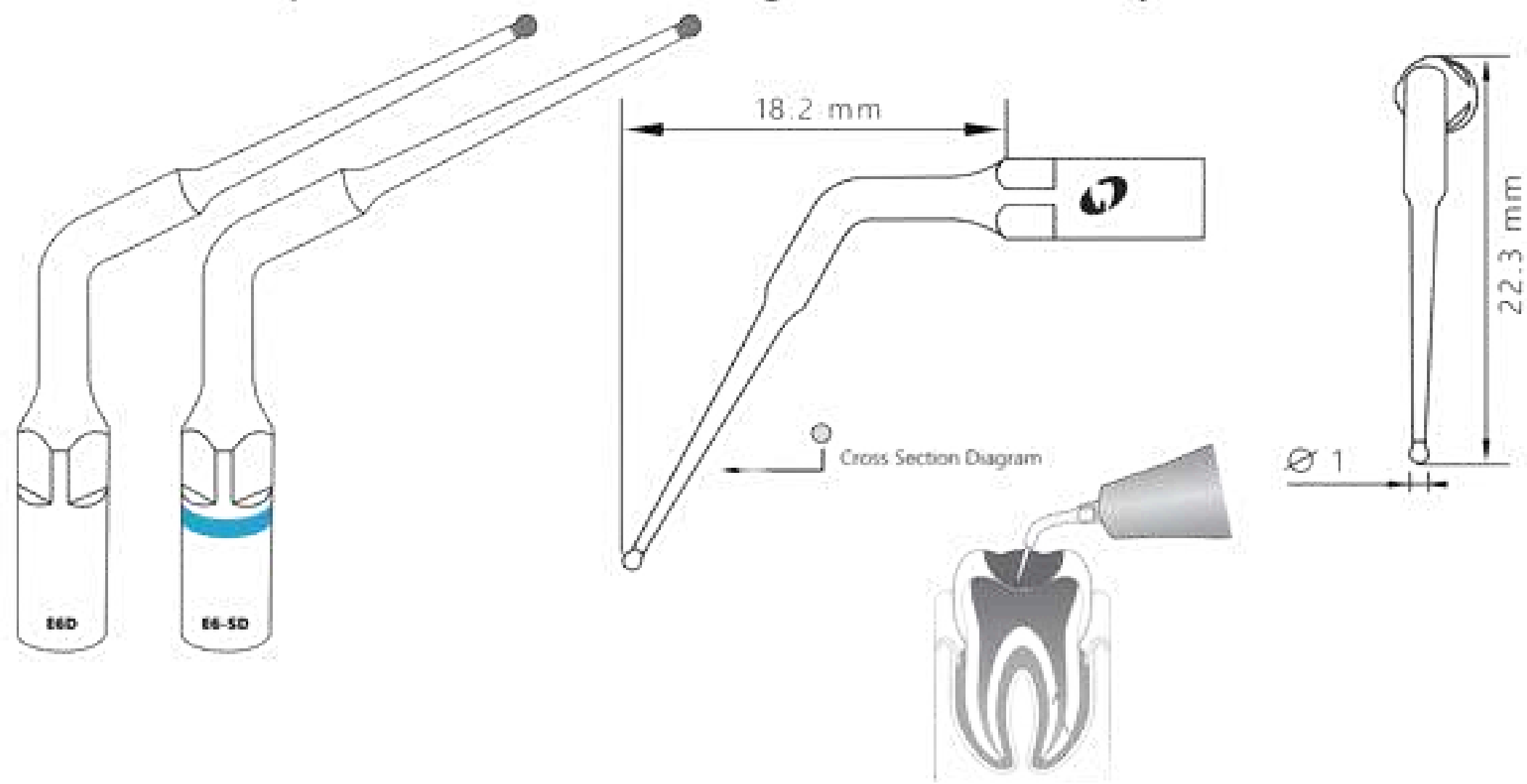

**EMS E7D SATELEC E7D-S**

Function Description: Removal of calcification and filling material in cavity to access canal orifice during re-treatment

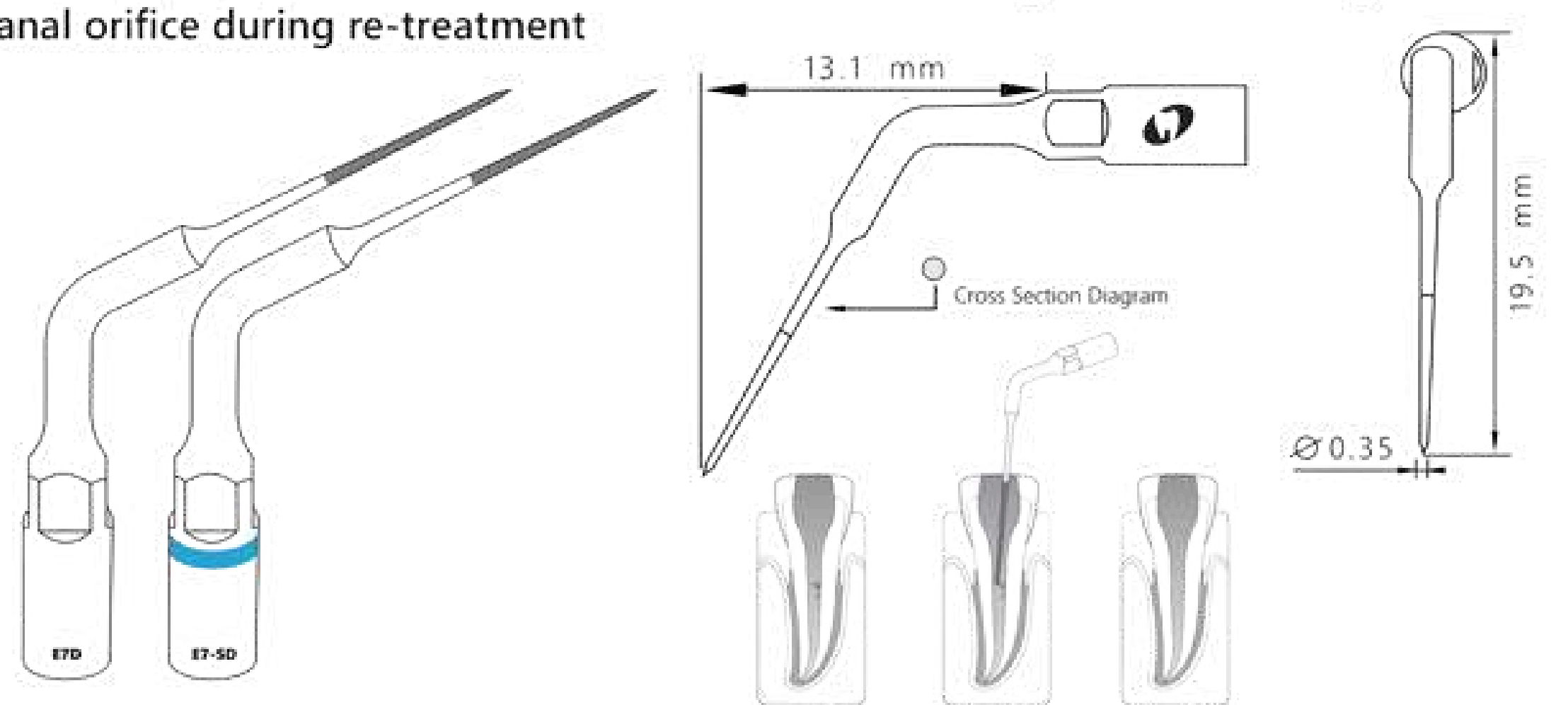

**EMS E8D SATELEC E8D-S**

Function Description: Used for root canal retrogression, efficient root apical polishing

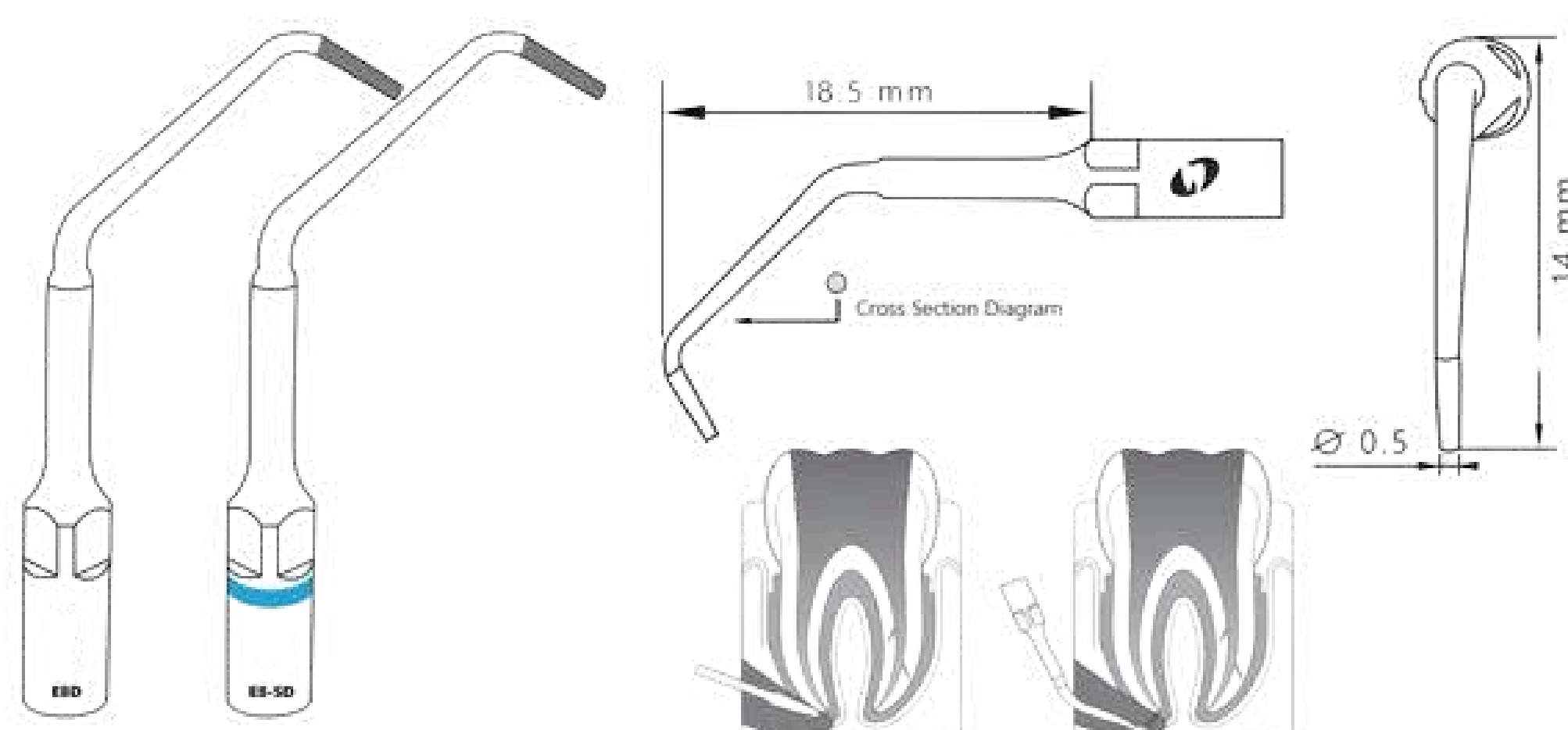

**EMS TC1D SATELEC TC1D-S**

Function Description: Removal cervical caries and caries on the occlusal surface

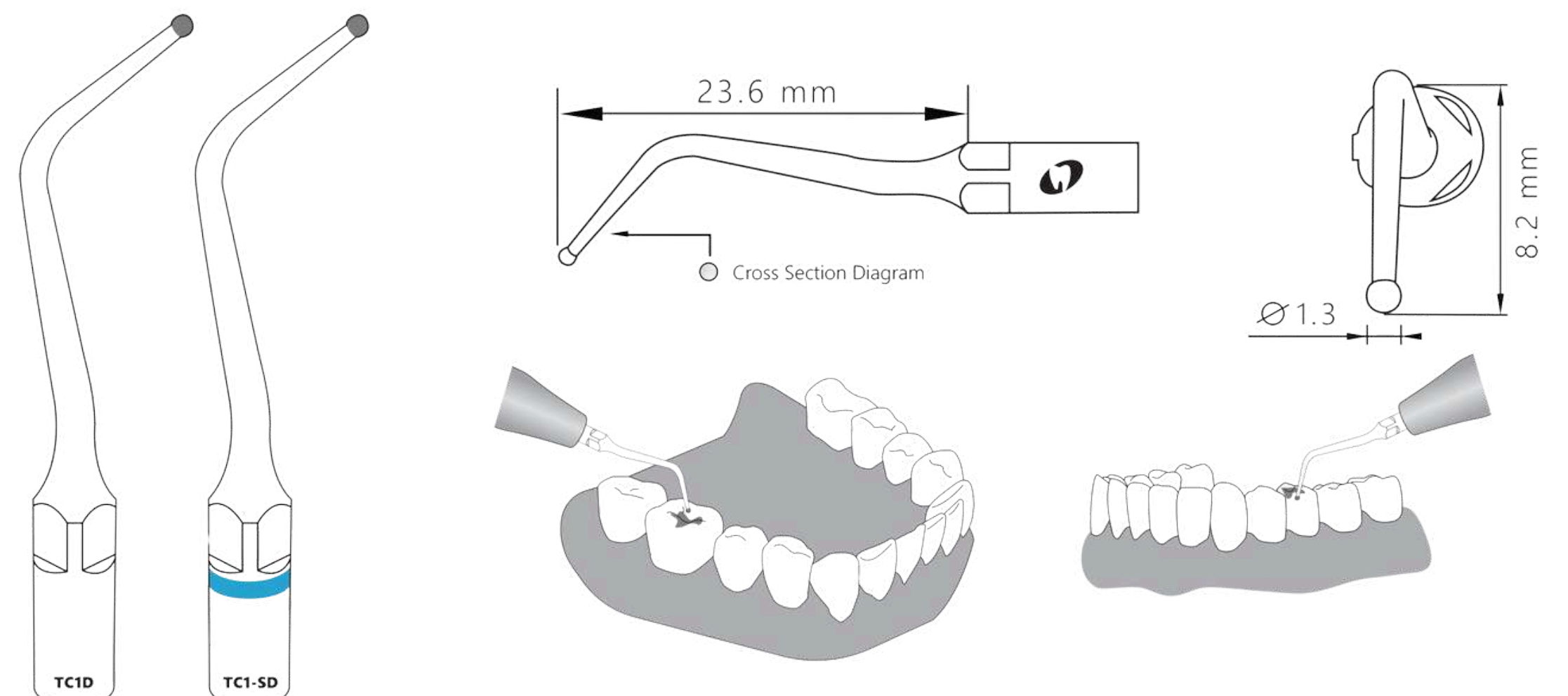

31,00€ + PDV

38,75€

24,80€ + PDV

31,00€

CIJENA S UKLJUČENIM PDV-OM

-20%

# POLIMERIZACIJSKE LAMPE

## CURING PEN / CURING PEN - E

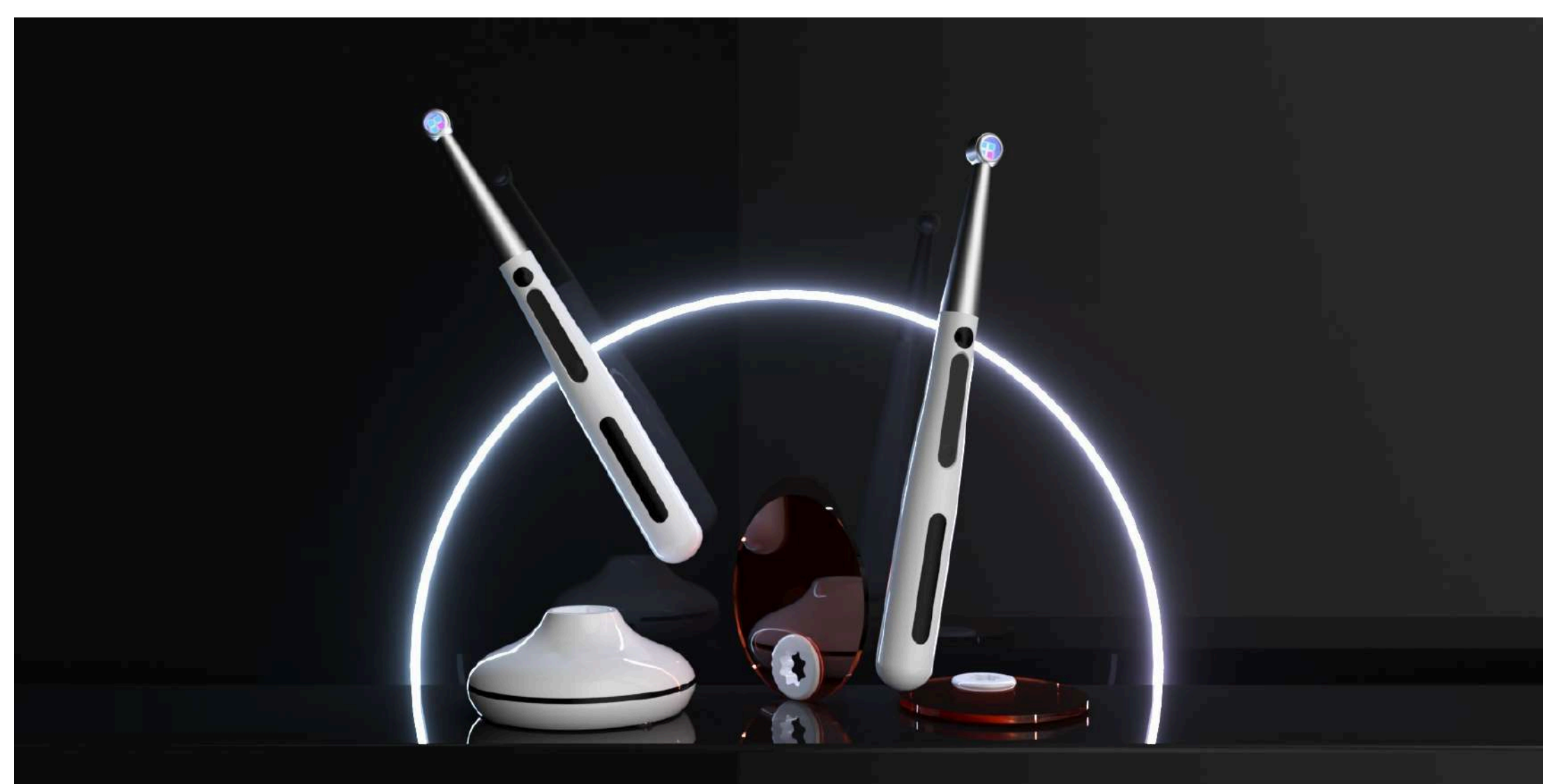

- 4 LEDs polimerizirajuća lampa
- Pametni upravljački čip
- Valna duljina: 385 – 515 nm
- 3 Blue, 1 Violet, 10w LED
- 360 ° rotirajuća glava
- Višestruke opcije – Ramp mode i Pulse mode

250,00 € + PDV

CIJENA S UKLJUČENIM PDV-OM  
**312,50 €**



- Led polimerizacijska lampa
- 360° rotirajuća glava
- inteziteta do 3000 mw/cm
- 5 podesivih programa



220,00 € + PDV

CIJENA S UKLJUČENIM PDV-OM  
**275,00 €**

## CONTEC DENTALNI KOLČIĆI

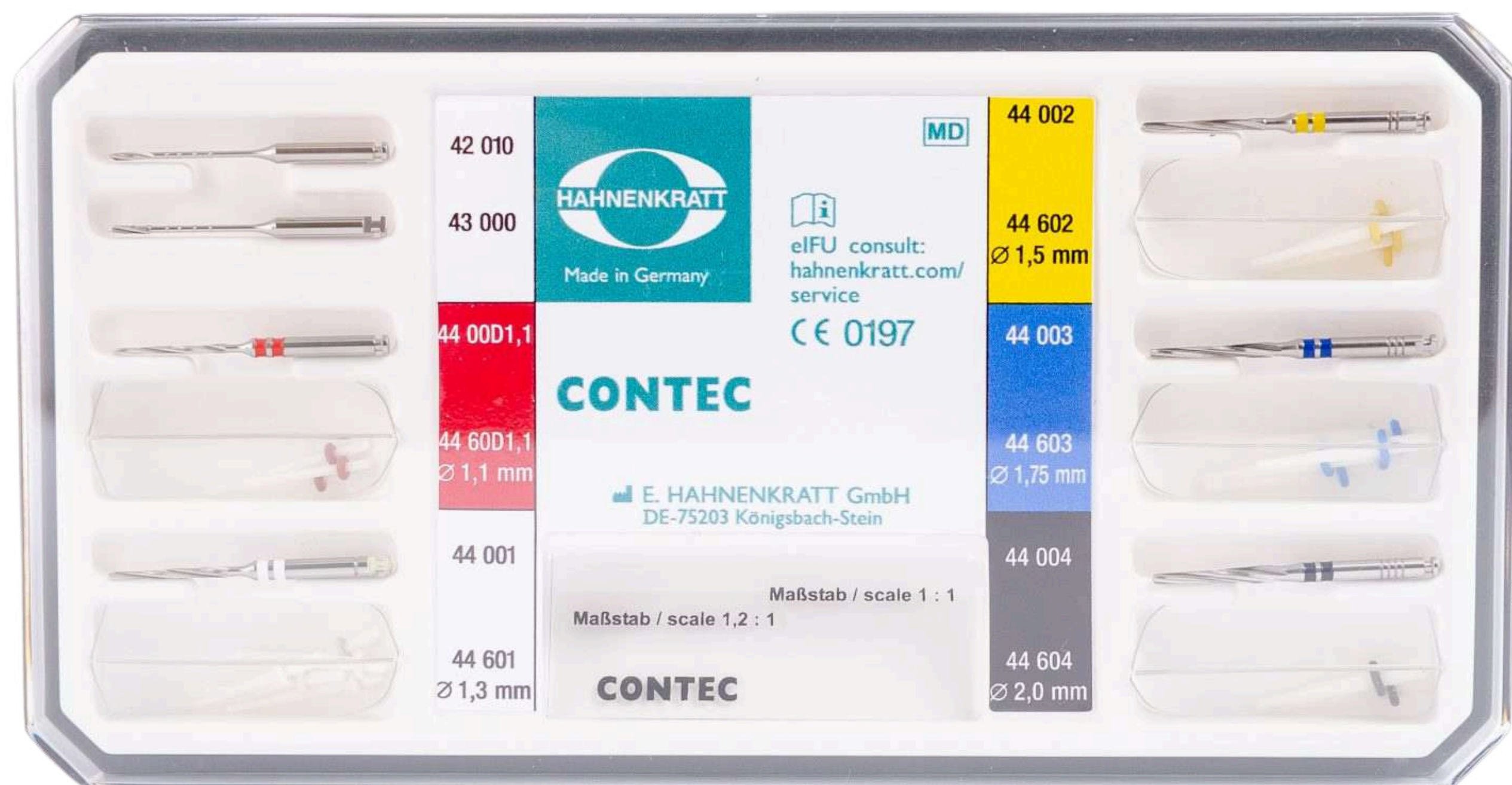

### SET SADRŽI:

- CRVENI KOLČIĆI, Ø 1,1 MM, 3 KOM
- BIJELI KOLČIĆI, Ø 1,3 MM, 5 KOM
- ŽUTI KOLČIĆI, Ø 1,5 MM, 5 KOM
- PLAVI KOLČIĆI, Ø 1,75 MM, 5 KOM
- CRNI KOLČIĆI, Ø 2,0 MM, 2 KOM
- SVRDLA, 7 KOM

SET  
~~235,00€ + PDV~~      246,75€  
 211,50€ + PDV      222,08€  
 CIJENA S UKLJUČENIM PDV-OM

-10%

### REFIL 10KOM + SVRDLO GRATIS

100,00€ + PDV      105,00€  
 CIJENA S UKLJUČENIM PDV-OM

## EXATEC DENTALNI KOLČIĆI S BATALJKOM



### SET SADRŽI:

- KOLČIĆI VELIČINA 1, 5 KOM
- KOLČIĆI VELIČINA 2, 5 KOM
- KOLČIĆI VELIČINA 3, 5 KOM
- KOLČIĆI VELIČINA 5, 5 KOM
- SVRDLA, 6 KOM

SET  
~~250,00€ + PDV~~      262,50€  
 225,00€ + PDV      236,25€  
 CIJENA S UKLJUČENIM PDV-OM

-10%

### REFIL 10 KOM + SVRDLO GRATIS

115,00€ + PDV      120,75€  
 CIJENA S UKLJUČENIM PDV-OM

## FANTA V-TAPER GOLD

VISOKO ELASTIČNI NITI MATERIJAL

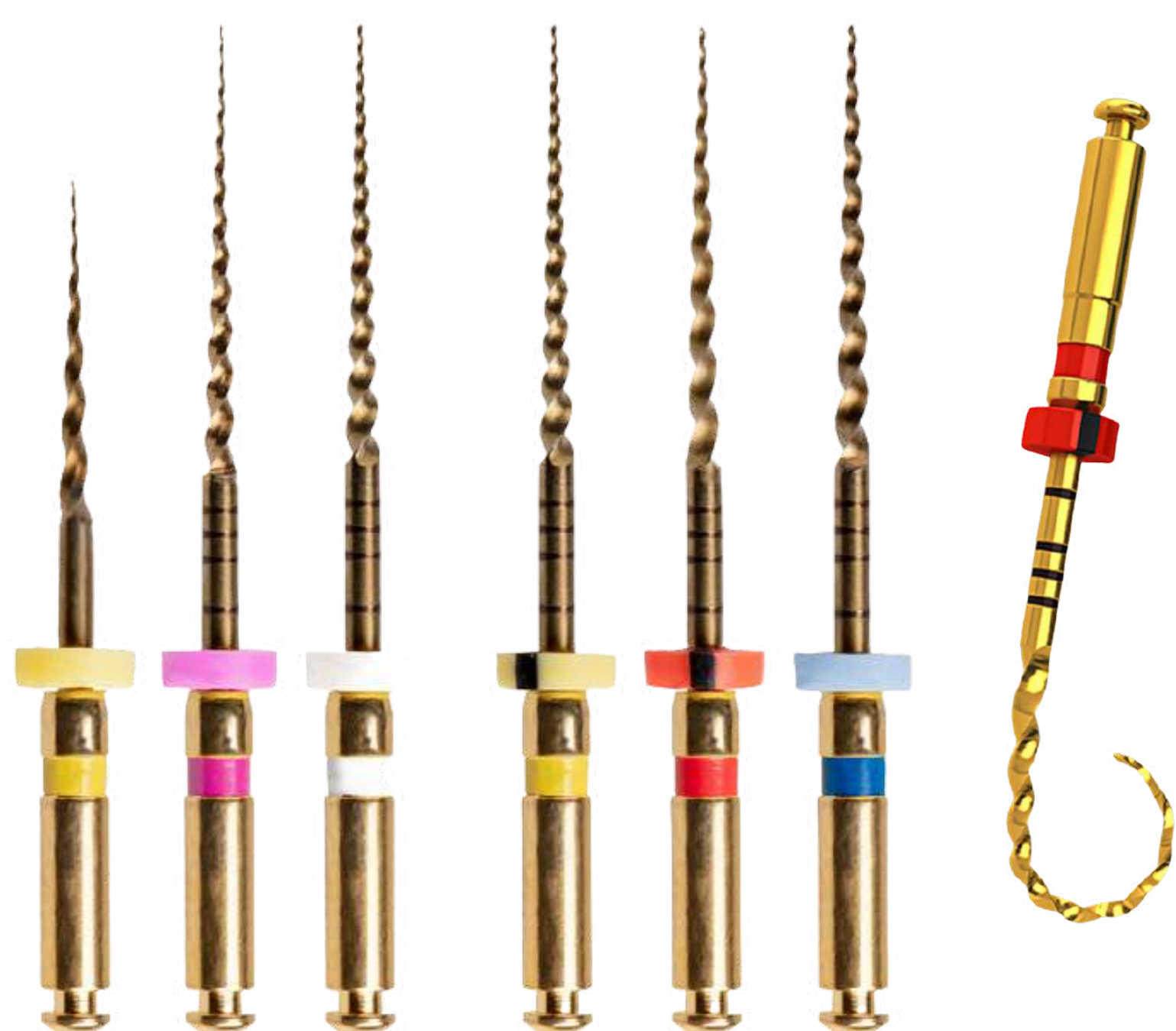

### PAKIRANJE SADRŽI 6 IGLICA

Asortiman iglica SX, S1, S2, F1, F2, F3, duljine 21mm, 25mm, 31mm ili zasebne veličine SX, S1, S2, F1, F2, F3, F4, F5 sa duljinama 25mm ili 31mm

34,00€ + PDV

42,50€

27,20€ + PDV

**34,00€**

-20%

CIJENA S UKLJUČENIM PDV-OM



## AF BLUE R3 RECIPROC



### PAKIRANJE SADRŽI 3 ISTE IGLICE

- VELIČINA #25 - 4%, DULJINA 25MM
- VELIČINA #25 - 6%, DULJINA 25MM
- VELIČINA #40 - 6%, DULJINA 25MM

34,00€ + PDV

42,50€

27,20€ + PDV

**34,00€**

-20%

CIJENA S UKLJUČENIM PDV-OM

## FANTA AF C-PATH FILES



### PAKIRANJE SADRŽI 4 IGLICE

- VELIČINA #17 - 8%, DULJINA 19MM
- VELIČINA #13 - 2%, DULJINA 25MM
- VELIČINA #16 - 2%, DULJINA 25MM
- VELIČINA #19 - 2%, DULJINA 25MM

34,00€ + PDV

27,20€ + PDV

**34,00€**

-20%

CIJENA S UKLJUČENIM PDV-OM

## FANTA AF ONE



### PAKIRANJE SADRŽI

- 1 X OPEN FILE (#17 / 12% / 19 MM)
- 3X ONE FILE (#25 / 4% ILI 6% / 25 MM)

34,00€ + PDV

42,50€

27,20€ + PDV

**34,00€**

-20%

CIJENA S UKLJUČENIM PDV-OM

## AF ROTARY

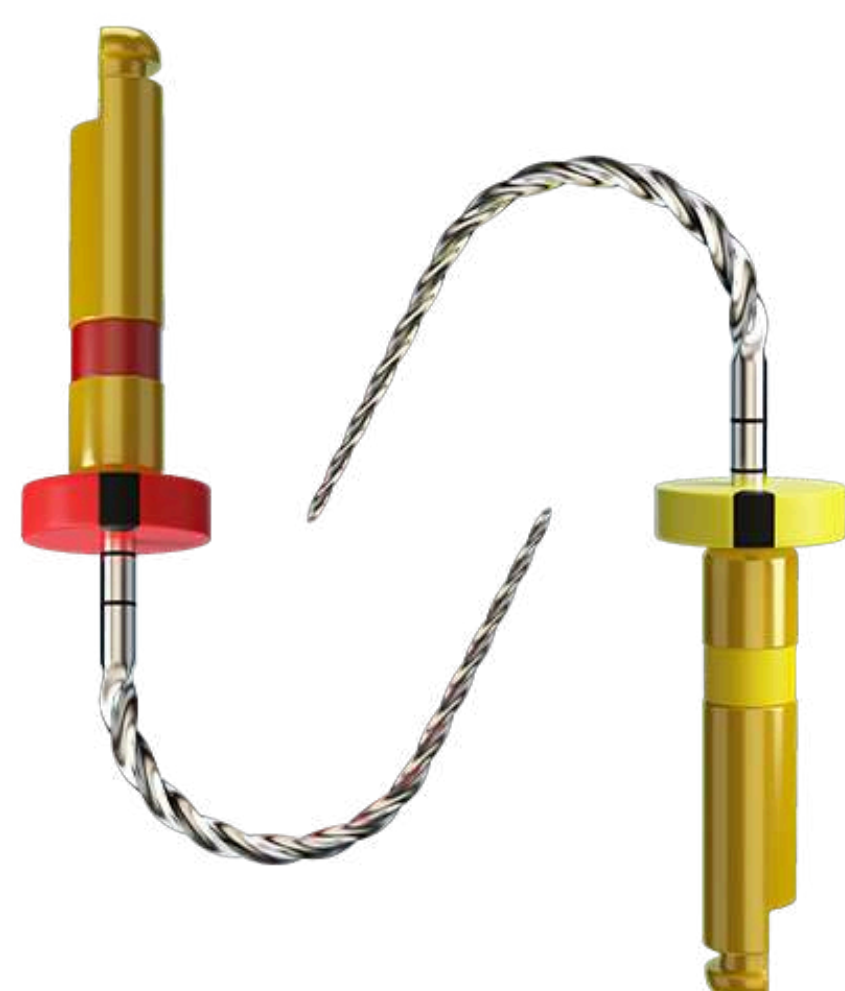

### PAKIRANJE SADRŽI 5 IGLICA

- VELIČINA #17 - 9%, DULJINA 19MM
- VELIČINA #19 - 2%, DULJINA 25MM
- VELIČINA #20 - 4%, DULJINA 25MM
- VELIČINA #25 - 4%, DULJINA 25MM
- VELIČINA #30 - 4%, DULJINA 25MM

34,00€ + PDV

42,50€

27,20€ + PDV

**34,00€**

-20%

CIJENA S UKLJUČENIM PDV-OM



## AF RETREATMENT



### IGLICE ZA REVIZIJU

### PAKIRANJE SADRŽI 3 IGLICE

- VELIČINA #20 - 7%, DULJINA 22MM
- VELIČINA #25 - 8%, DULJINA 18MM
- VELIČINA #30 - 9%, DULJINA 16MM

34,00€ + PDV

42,50€

27,20€ + PDV

**34,00€**

-20%

CIJENA S UKLJUČENIM PDV-OM

## EIGHTEETH E-FLEX RECIPROC- SET

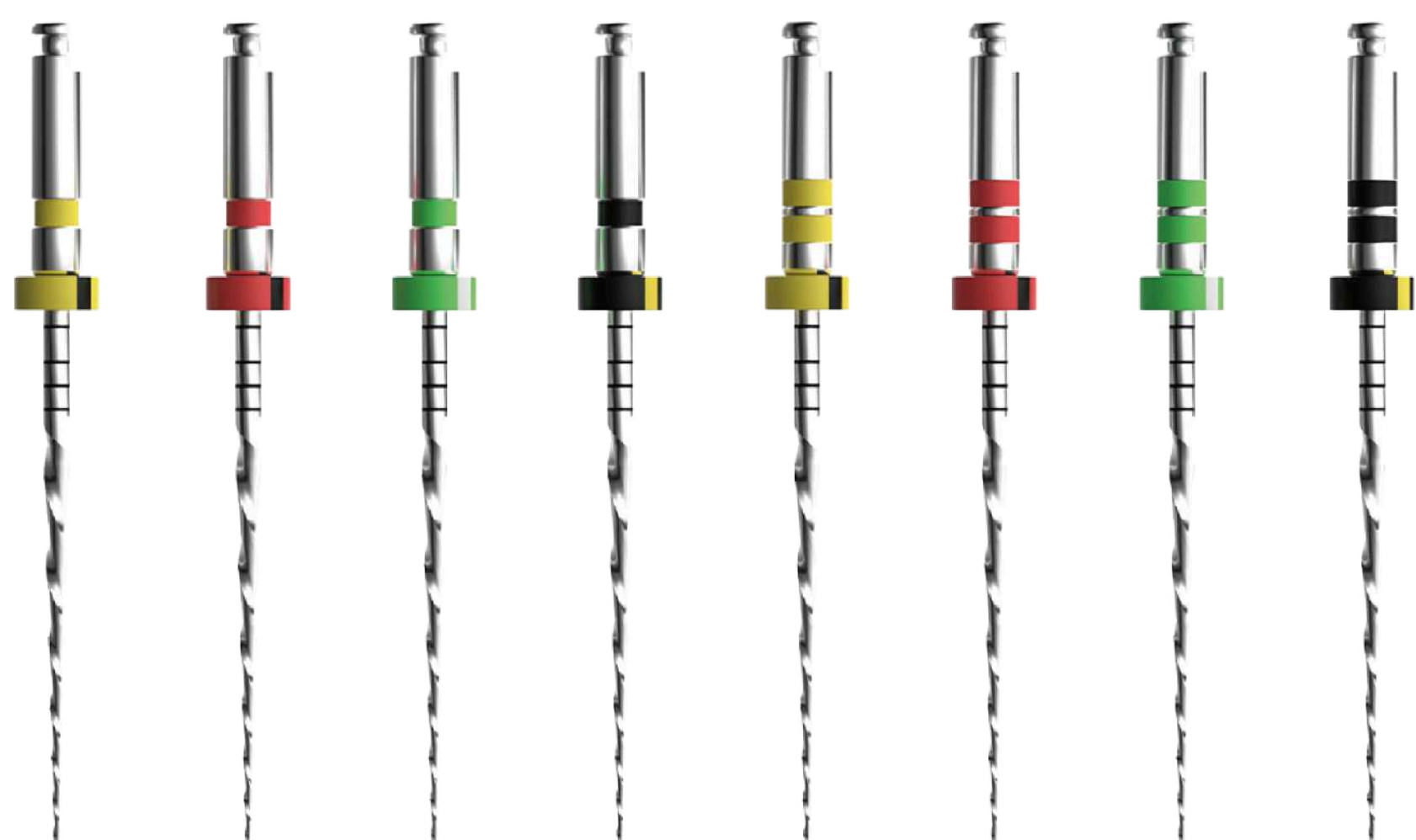

### SET SADRŽI 4 IGLICA

SET 1 SET 2 25mm, 31 mm  
20/04, 20/06  
25/04, 25/06  
35/04, 35/06  
40/04, 40/06

34,00€ + PDV 42,50€

27,20€ + PDV **34,00€**  
CIJENA S UKLJUČENIM PDV-OM

-20%

## AF MAX 3

Super fleksibilna iglica za završno čišćenje kanala

**PAKIRANJE SADRŽI 3 ISTE IGLICE**

VELIČINA #25 - 1%, DULJINA 25MM



34,00€ + PDV

42,50€

27,20€ + PDV

**34,00€**

CIJENA S UKLJUČENIM PDV-OM

-20%

## GUTTA PERCHA I PAPIRNATI ŠILJCI

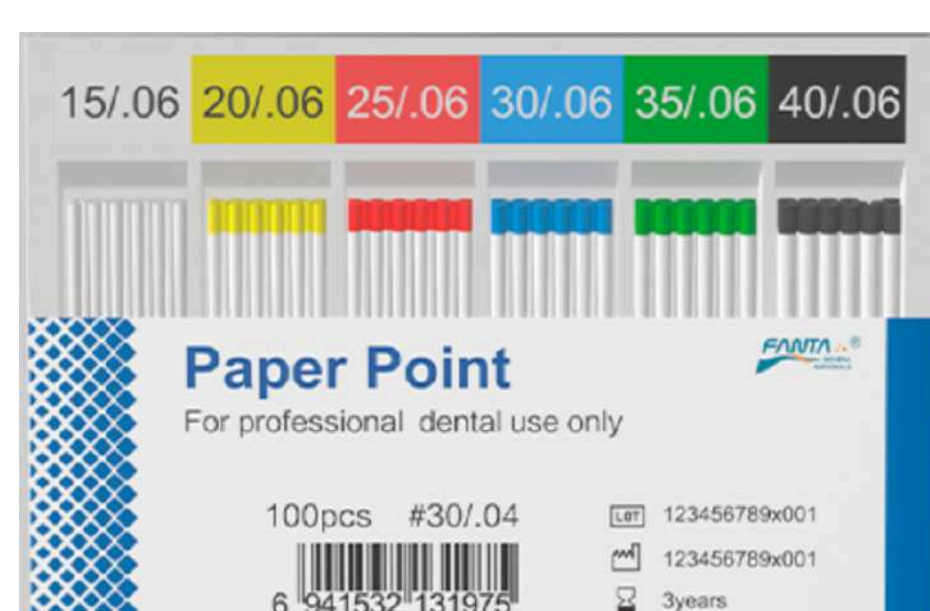

- 2 % #15 #20 #25 #30 #35 #40  
#15-40 (SET) #45-80 (SET)
- 4 % #20 #25 #30 #15-40 (SET)
- 6 % #20 #25 #30 #15-40 (SET)

9,95€ + PDV

12,44€

7,47€ + PDV

**9,95€**

CIJENA S UKLJUČENIM PDV-OM

-20%

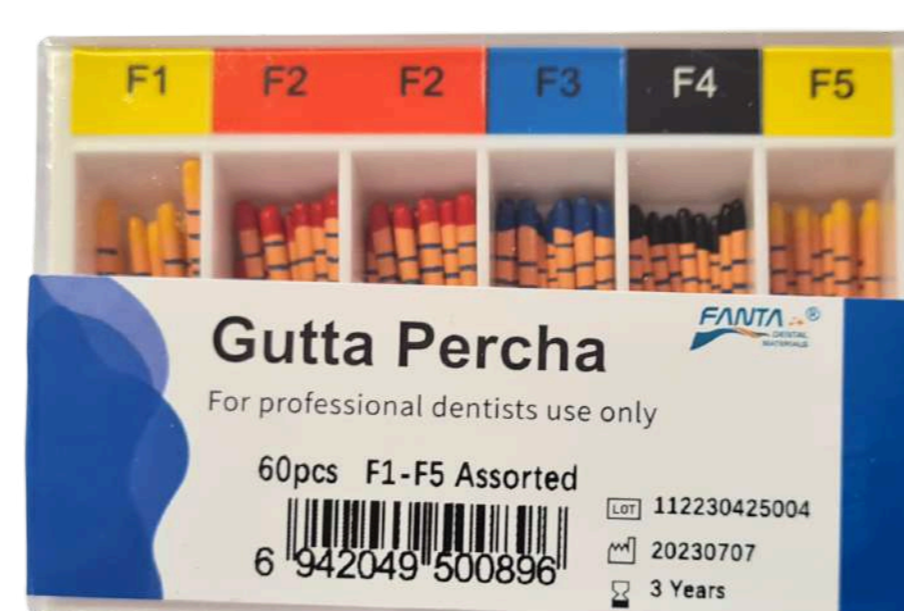

- #F1 #F2 #F3 #F4 #F5
- #F1-F5 (SET)

18,00€ + PDV

22,50€

14,40€ + PDV

**18,00€**

CIJENA S UKLJUČENIM PDV-OM

-20%

## FANTA K-FILES, H-FILES, C-FILES IGLICE



K-FILE I H-FILE

**PAKIRANJE SADRŽI 6 IGLICA**

DOSTUPNE VELIČINE:

#06, #08, #10, #15, #20, #25,  
#30, #35, #40, #15-40, #45-80

C-FILE

**PAKIRANJE IGLICA**

DOSTUPNE VELIČINE:

#06, #08, #10, #12

9,95€ + PDV

12,44€

7,96€ + PDV

**9,95€**

CIJENA S UKLJUČENIM PDV-OM

-20%



## IGLICE ZA RUČNU ENDODONCIJU MANI



PAKIRANJE SADRŽI 6 IGLICA

DOSTUPNE DULJINE:  
25 MM ILI 31 MM

DOSTUPNE VELIČINE:  
#06 #08 #10 #15 #20 #25  
#30 #35#40 #15-40 #45-80

9,95€ + PDV 12,44€

7,96€ + PDV **9,95€**

CIJENA S UKLJUČENIM PDV-OM

-20%

## PLUGGERI



DOSTUPNE VELIČINE:

#35/03 - #70/02  
#40/03 - #80/02  
#50/03 - #100/02  
#60/03 - # 120/02

19,00€ + PDV 23,75€

15,20€ + PDV **19,00€**

CIJENA S UKLJUČENIM PDV-OM

-20%

## REZAČ GUTAPERKI



64,81€ + PDV 76,25€

51,85€ + PDV **64,81€**

CIJENA S UKLJUČENIM PDV-OM

-20%

## IRIGACIJSKE IGLE



PAKIRANJE OD 20 KOM

DOSTUPNE DULJINE: 22 I 26 MM

10,95€ + PDV 13,69€

8,76€ + PDV **10,95€**

CIJENA S UKLJUČENIM PDV-OM

-20%

## FANTA ENDO BOX

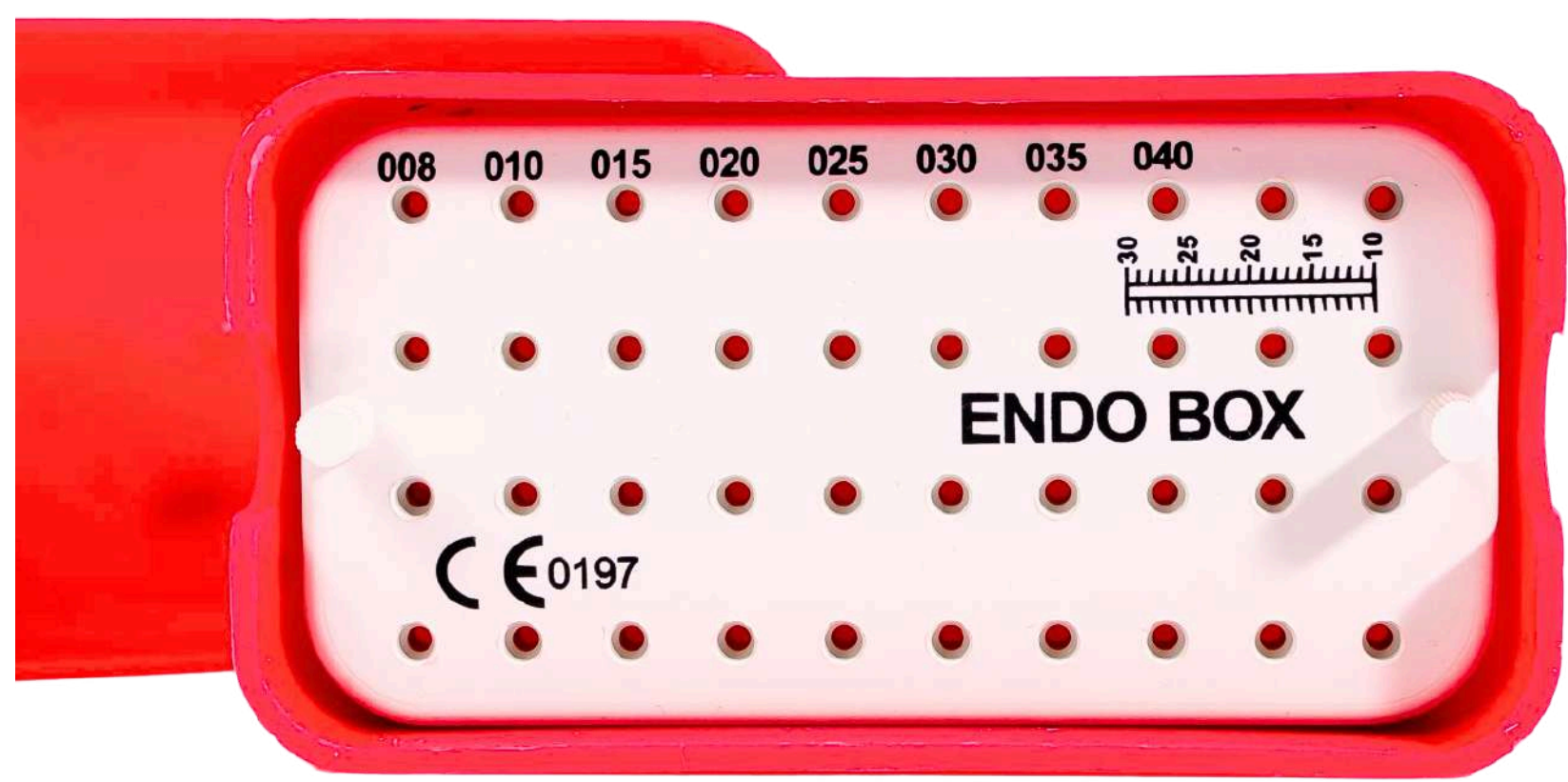

21,00€ + PDV 26,25€

16,80€ + PDV 21,00€  
CIJENA S UKLJUČENIM PDV-OM

-20%

## NERV IGLE

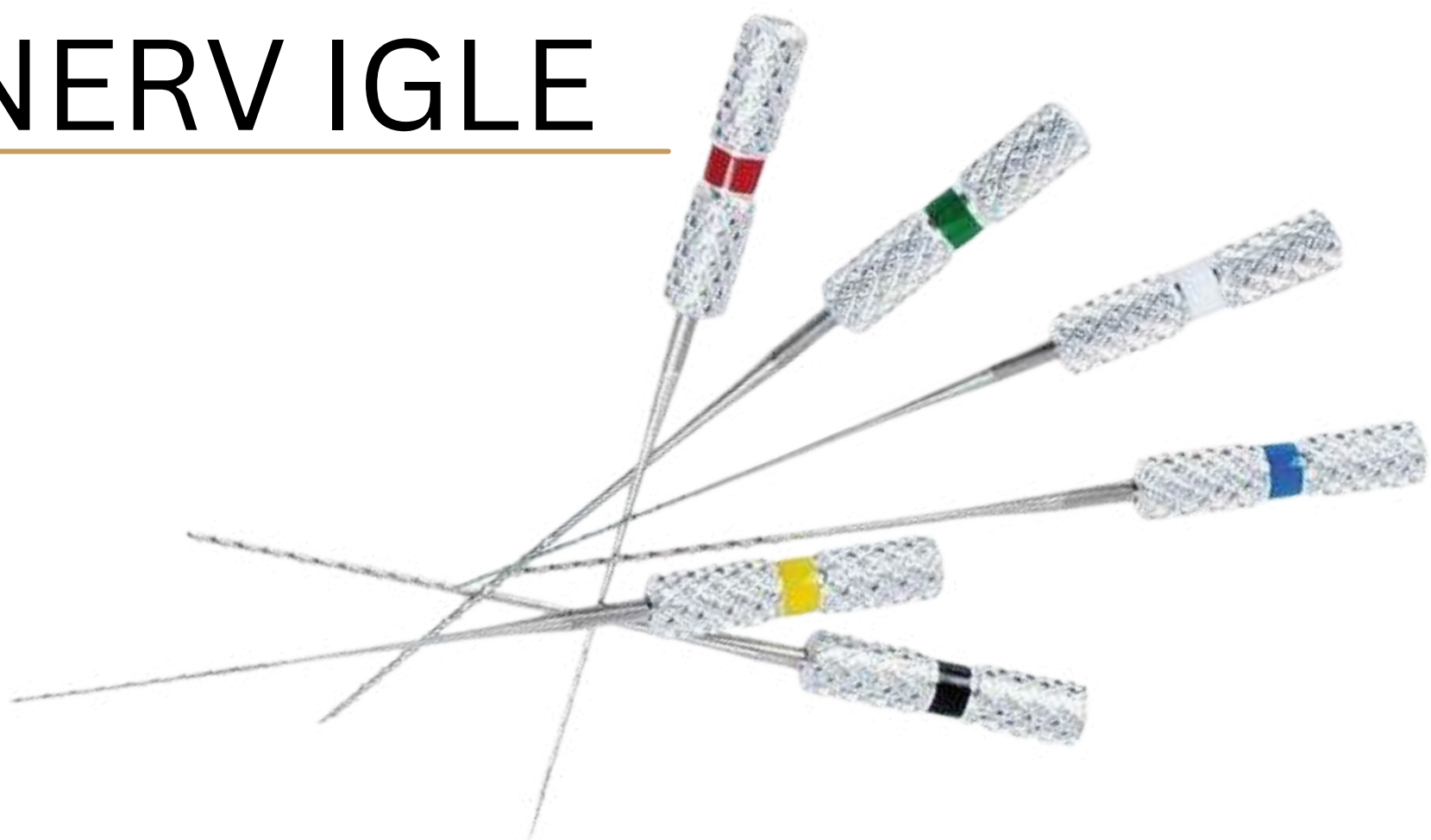

PAKIRANJE SADRŽI 6KOM

DOSTUPNE VELIČINE: 1, 2, 3 - SET 1-6

12,00€ + PDV 15,00€

9,60€ + PDV 12,00€  
CIJENA S UKLJUČENIM PDV-OM

-20%

## AR ENDO BOX

OPCIJE:

- OKRUGLI
- PRAVOKUTNI



40,14€ + PDV 50,17€

32,11€ + PDV 40,14€  
CIJENA S UKLJUČENIM PDV-OM

-20%

## GATES DRILLS



Gates Drills



PAKIRANJE SADRŽI 6KOM

DOSTUPNE VELIČINE: 1, 2, 3 - SET 1-6

16,00€ + PDV 20,00€

12,80€ + PDV 16,00€  
CIJENA S UKLJUČENIM PDV-OM

-20%

## PEESO REAMERS



PAKIRANJE SADRŽI 6KOM

DOSTUPNE VELIČINE: 1, 2, 3 - SET 1-6

15,95€ + PDV 19,93€

12,76€ + PDV 15,95€  
CIJENA S UKLJUČENIM PDV-OM

-20%

## LENTULO / PASTE CARRIERS



PAKIRANJE OD 4 IGLICE

DOSTUPNE VELIČINE: 25, 30, SET 25-40

12,50€ + PDV 15,62€

10,00€ + PDV 12,50€  
CIJENA S UKLJUČENIM PDV-OM

-20%

## NT BIOCERA FLO



BIOKERAMIČKO PUNILO KORIJENSKIH KANALA korištenje u kombinaciji sa guta perkom ili samostalno

72,00€ + PDV

75,60€

57,60€ + PDV

60,48€

CIJENA S UKLJUČENIM PDV-OM

-20%

## NT EDTA



17% EDTA GEL SA KARBAMID PEROKSIDOM za proširivanje korijenskih kanala omogućujući pritom poboljšano klizanje iglica

7,50€ + PDV

7,88€

6,00€ + PDV

6,24€

CIJENA S UKLJUČENIM PDV-OM

-20%

## PD ENDOPLUS

Dvokomponentno punilo/pasta dual syringe za punjenje korijenskih kanala bazirano na epoksiju.

Prikladno za sve tehnike punjenja kanala.



PAKIRANJE:

- 13,5 G DUAL SIRINGA (EPOXY RESIN,CALCIUM PHOSPHATE)
- CATALYST 4.5 G (AMINES,BISMUTH SUBCARBONATE)
- SPATULA, MIXING PLATE

50,00€ + PDV

52,50€

40,00€ + PDV

42,00€

CIJENA S UKLJUČENIM PDV-OM

-20%

## NT BIO MTA



MINERAL TRIOKSID AGREGAT

Materijal za prekrivanje pulpe, zatvaranje furkacije, prekrivanje defekta korijena, zatvaranje fausse route-a, apeksogeneza i apeksifikacija

57,23€ + PDV

60,09€

45,78€ + PDV

48,07€

CIJENA S UKLJUČENIM PDV-OM

-20%

## NT PEX

KALCIJ HIDROKSID PASTA SA JODOFORMOM

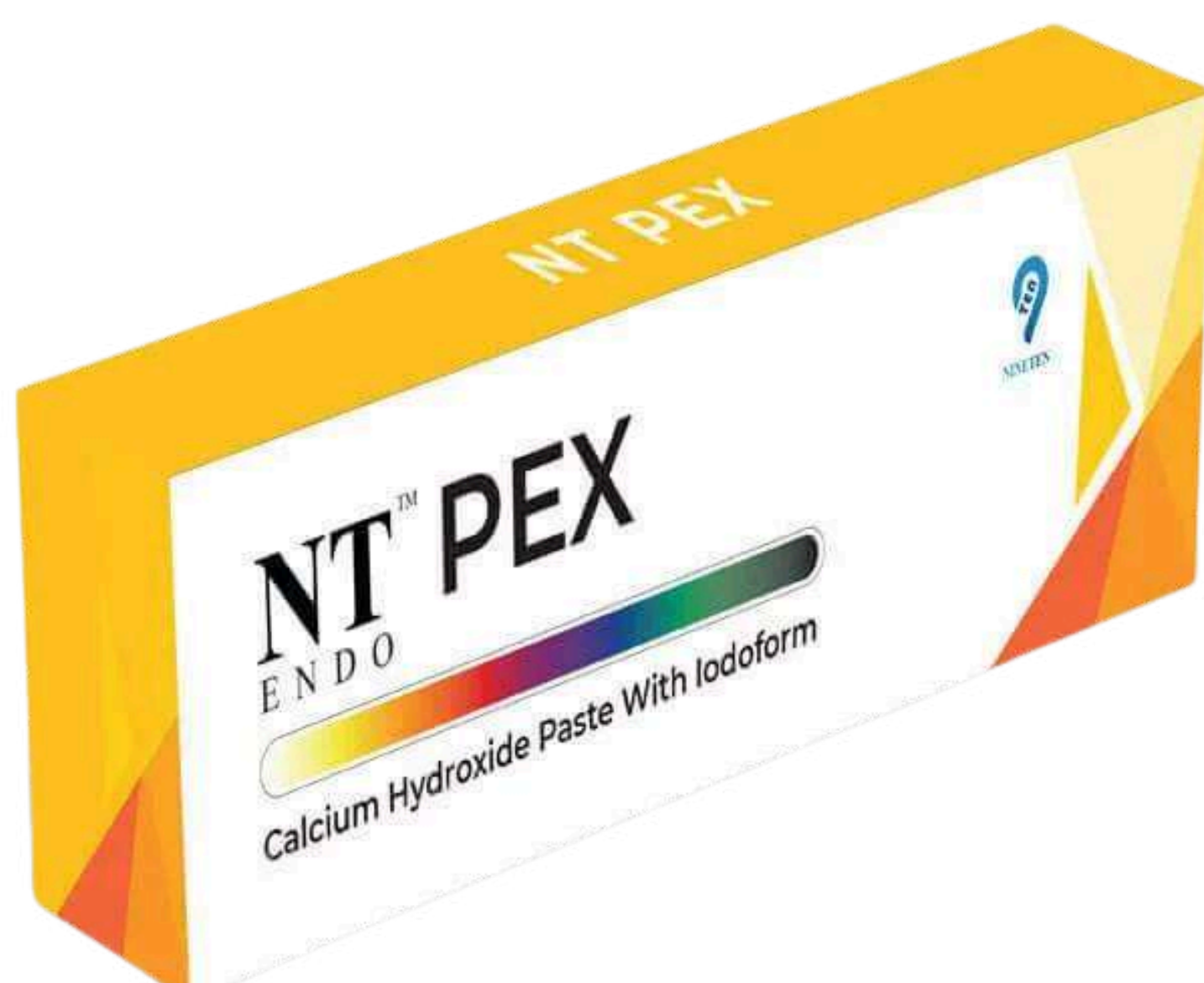

19,96€ + PDV

20,95€

15,96€ + PDV

16,76€

CIJENA S UKLJUČENIM PDV-OM

-20%

## NT CAL

KALCIJ HIDROKSID PASTA za brtvljenje korijenskih kanala



19,96€ + PDV

20,95€

15,96€ + PDV

16,76€

CIJENA S UKLJUČENIM PDV-OM

-20%

## ZENIT I ZENIT SET NANO KERAMIČKI KOMPOZIT

### PAKIRANJE SET:

- 7x4gr Syringe (A1, A2, A3, A3.5, B2, A20, W2),
- bond, gel za jetkanje, 1x A2 Dynamic Flow
- Dynamic flow tekući kompozit, aplikatore i pribor



367,38 € + PDV ~~385,75€~~

275,54 € + PDV 289,32€  
CIJENA S UKLJUČENIM PDV-OM

-25%

## ZENCHROMA

Svjetlosno polimerizirajući mikrohibridni kompozit  
Mimikrija na 16 VITA boja od A1-C4 u jednoj šprici



### PAKIRANJE:

1 x 4g refill šprica ili 1 x 4g opaker

28,57 € + PDV ~~30,00€~~

22,85 € + PDV 23,99€  
CIJENA S UKLJUČENIM PDV-OM

-20%

41,00 € + PDV ~~43,05€~~

32,80 € + PDV 34,44€  
CIJENA S UKLJUČENIM PDV-OM

-20%

### POJEDINAČNI KOMPOZIT:

- 1 x siringa 4g, A1, A2, A3 ili A3.5



41,00 € + PDV ~~43,05€~~

32,80 € + PDV 34,44€  
CIJENA S UKLJUČENIM PDV-OM

-20%

### STARK BULK FLOW



BOJA • universal

25,74 € + PDV ~~27,03€~~

20,60 € + PDV 21,62 €  
CIJENA S UKLJUČENIM PDV-OM

-20%

### DYNAMIC PLUS

#### PAKIRANJE:

A1, A2, A3, A3.5  
4 g šprica



25,00 € + PDV ~~26,25€~~

20,00 € + PDV 21,00€  
CIJENA S UKLJUČENIM PDV-OM

-20%

### DYNAMIC FLOW

#### PAKIRANJE:

• A1, A2, A3, A3.5  
4 g šprica



25,00 € + PDV ~~26,25€~~

20,00 € + PDV 21,00€  
CIJENA S UKLJUČENIM PDV-OM

-20%

## PREBOND SE

- Bond 7. generacije.  
Samojetkajući, 5 ml.



## EXTRACEM

Staklenoionomerni cement za cementiranje krunica, mostova, inlays, onlays, nadogradnji i ortodontskih bravica

- 35 g prah
- 17ml tekućina
- Blok za mješanje, žlica



~~41,00 € + PDV~~ ~~43,05€~~

28,70 € + PDV 30,13€

CIJENA S UKLJUČENIM PDV-OM

-30%

~~49,85 € + PDV~~ ~~52,34€~~

39,88 € + PDV 41,87€

CIJENA S UKLJUČENIM PDV-OM

-20%

## GEL ZA JETKANJE

3 ml



3+2

~~8,50 € + PDV~~

26,80€

CIJENA S UKLJUČENIM PDV-OM

## ZENIT CEM / CEMENT

Trajni samoadhezivni cement sa dvostrukim stvrdnjavanjem za indirektnu restauraciju (inlays, onlays, krunice, mostovi, endodontski kolčići), cirkon, staklokeramiku

TR ili A2 9,6 g + 10 mješača

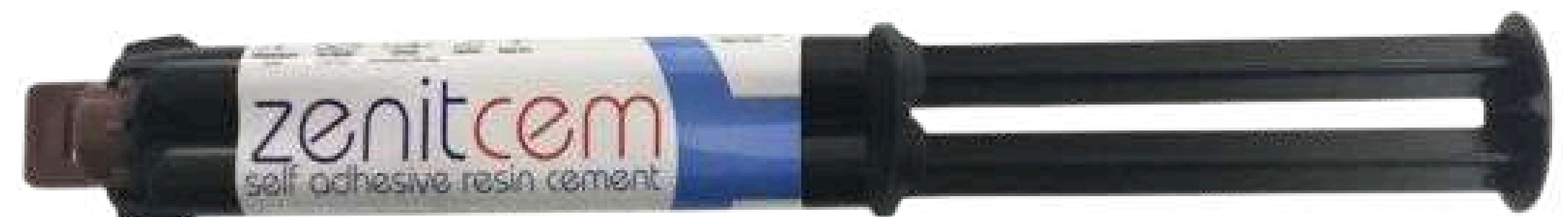

~~80,00 € + PDV~~

~~84,00€~~

64,00 € + PDV

67,20€

CIJENA S UKLJUČENIM PDV-OM

-20%

## PROSHIELD VARNISH

5% fluoridni premaz, pomaže kod preosjetljivosti zuba, pakiranje: 32 tube

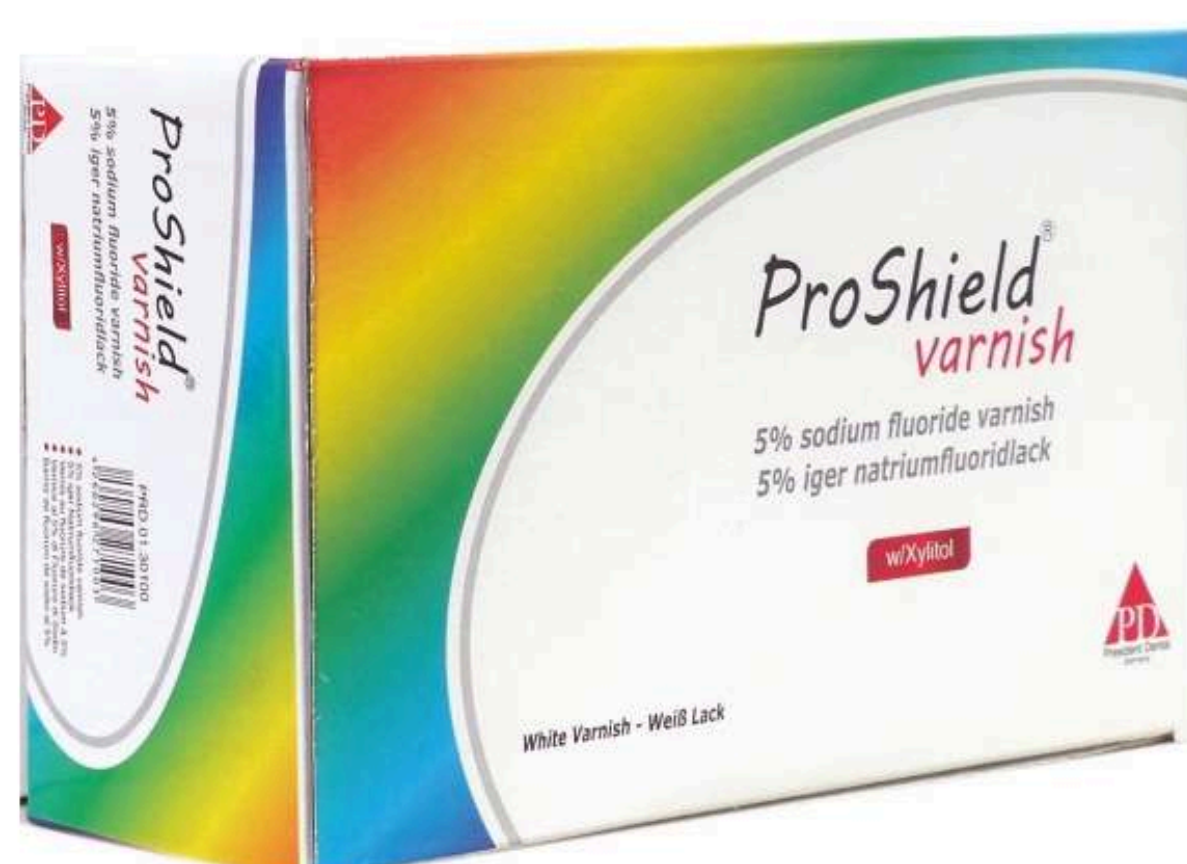

~~75,00 € + PDV~~

~~75,85€~~

60,00 € + PDV

63,00€

CIJENA S UKLJUČENIM PDV-OM

-20%

## PROCEM

Privremeni cement bez eugenola



~~35,00 € + PDV~~

~~36,75€~~

28,00 € + PDV

29,40 €

CIJENA S UKLJUČENIM PDV-OM

-20%

## I-SMILE

4 x3g šprica, 16% karbamid peroksid s fluorom, okus jabuke



~~56,19 € + PDV~~ ~~59,00 €~~

39,33 € + PDV 41,30 €

CIJENA S UKLJUČENIM PDV-OM

-30%

## I-SEAL LC 3,8g + 3 tips

Za pečačenje fisura

Visoko protočan, veže se za caklinu

Niska viskoznost

Učinkovita zaštita od karijesa



~~22,38 € + PDV~~ ~~23,50 €~~

15,66 € + PDV 16,45 €

CIJENA S UKLJUČENIM PDV-OM

-30%

## I-PRO LC 2x4g

Svjetlosno polimerizirajući materijal za privremeni ispun



~~14,28 € + PDV~~ ~~14,99 €~~

9,99 € + PDV 10,49 €

CIJENA S UKLJUČENIM PDV-OM

-30%

## I-FIX DUO

8g x10 mješalica

Dvostruko stvrdnjavajući samoadhezivni cement

Za trajno cementiranje kolčića, indirektno restauracije, keramiku, metal, inlay, onlay, krunice i mostove



~~50,00 € + PDV~~

~~52,50 €~~

35,00 € + PDV

36,75 €

CIJENA S UKLJUČENIM PDV-OM

-30%

## I-EDTA

Solution 250ml



~~47,14 € + PDV~~

~~49,50 €~~

33,18 € + PDV

34,84 €

CIJENA S UKLJUČENIM PDV-OM

-30%

# C-SILIKON

## DUROSIL L



28,35 € + PDV ~~28,35€~~

21,60 € + PDV 22,68€  
CIJENA S UKLJUČENIM PDV-OM

-20%

## DUROSIL S



17,00 € + PDV ~~17,85€~~

13,60 € + PDV 14,28€  
CIJENA S UKLJUČENIM PDV-OM

-20%

## PASTE HARDENER



15,41 € + PDV ~~16,80€~~

12,32 € + PDV 12,94€  
CIJENA S UKLJUČENIM PDV-OM

-20%

# A-SILIKON

## PRESSIGUM FAST BODY SET

### SADRŽAJ SETA:

- 2x 50 ml
- 10x mješači
- 5x žuti oralni vrhovi



39,50 € + PDV ~~41,48€~~

31,60 € + PDV 33,18€  
CIJENA S UKLJUČENIM PDV-OM

-20%

## PRESSIGUM LIGHT BODY SET

### SADRŽAJ SETA:

- 2x 50 ml
- 10x mješači
- 5x žuti oralni vrhovi



## PRESSIGUM PUTTY NORMAL

### SADRŽAJ SETA:

2x 250 ml



67,50 € + PDV ~~70,88€~~

54,00 € + PDV 56,70 €  
CIJENA S UKLJUČENIM PDV-OM

-20%

## PRESSIGUM PUTTY FAST

### SADRŽAJ SETA:

2x 250 ml



## MIKROAPLIKATORI - 4 KOM

GRANULACIJE: REGULAR, FINE,  
SUPERFINE



~~24,00 € + PDV~~ ~~30,00 €~~

16,80 € + PDV 21,00 €  
CIJENA S UKLJUČENIM PDV-OM

-30%

## RETRAKCIJSKI KONAC

VELIČINE: 000, 00, 0, 1



~~14,36 € + PDV~~ ~~17,95 €~~

10,05 € + PDV 12,57 €  
CIJENA S UKLJUČENIM PDV-OM

-30%

## I-OIL



~~20,40 € + PDV~~ ~~25,50 €~~

14,28 € + PDV 17,85 €  
CIJENA S UKLJUČENIM PDV-OM

-30%

## RESORPTIVNI - PGA RAPID 12KOM



- oblik igle RS-22 krug 1/2
- duljina konca 75 cm
- dostupne debljine 3/0, 4/0, 5/0

~~54,00 € + PDV~~ ~~56,70 €~~

43,20 € + PDV 45,36 €  
CIJENA S UKLJUČENIM PDV-OM

-20%

## NERESORPTIVNI - POLYPROPYLENE- 12KOM

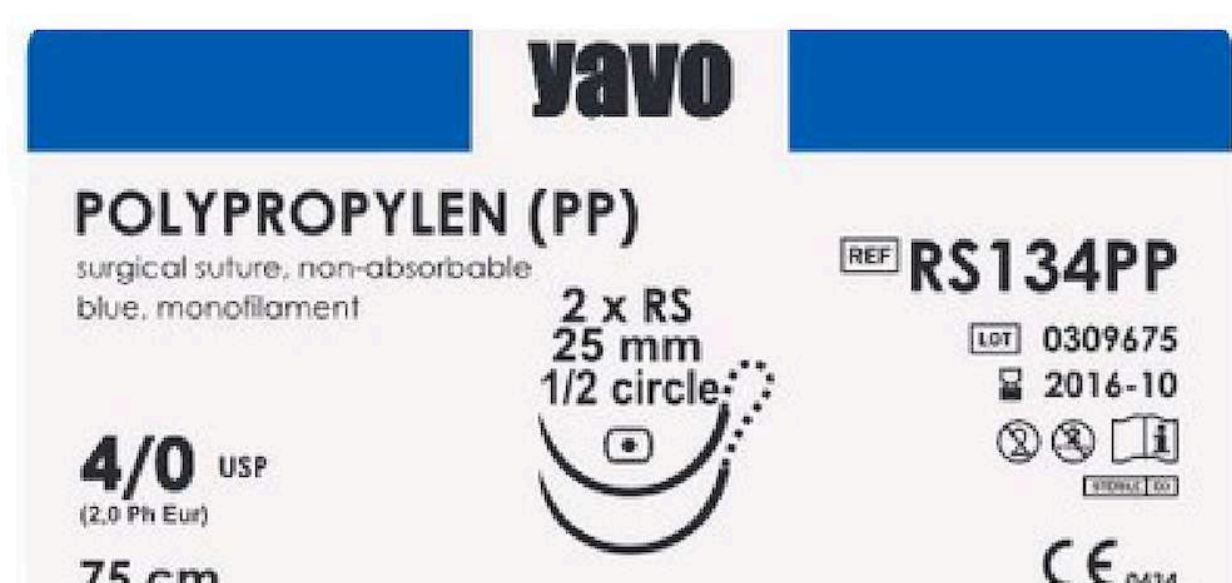

- oblik igle RS-22 krug 1/2
- duljina konca 75 cm
- dostupne debljine 3/0, 4/0
- debljina 5/0 - oblik igle RS-20

~~45,00 € + PDV~~ ~~47,25 €~~

36,00 € + PDV 37,80 €  
CIJENA S UKLJUČENIM PDV-OM

-20%

## NERESORPTIVNI - SILK 12KOM



- oblik igle RS-22 krug 1/2
- duljina konca 75 cm
- dostupne debljine 3/0, 4/0











~~42,00 € + PDV~~ ~~44,10 €~~











33,60 € + PDV 35,28 €  
CIJENA S UKLJUČENIM PDV-OM











-20%











# WILOFA DIJAMANTNA SVRDLA

RETARD	Flat Taper, Rounded End / Konus (Stirn flach, Kanten abgerundet)				Flat Taper / Konus (Stirn flach)					
										
n	R 544-016	R 545-016	R 545-023	R 546-016						
c				R 546-016 c		R 173-016 c	R 166-014 c	R 166-018 c	R 167-010 c	
f				R 546-016 f						
sc							R 166-014 sc	R 166-018 sc		R 167-014 sc

RETARD	Torpedo / Torpedo									
										
n	R 288-012	R 288-014	R 289-010	R 289-012	R 289-014	R 289-016	R 290-012	R 290-014	R 290-016	R 291-014
c	R 288-012 c	R 288-014 c	R 289-010 c	R 289-012 c	R 289-014 c	R 289-016 c	R 290-012 c	R 290-014 c	R 290-016 c	R 291-014 c
f	R 288-012 f	R 288-014 f	R 289-010 f	R 289-012 f	R 289-014 f	R 289-016 f	R 290-012 f	R 290-014 f	R 290-016 f	R 291-014 f
sc							R 290-012 sc		R 290-016 sc	

RETARD	Round End Taper / Konus (Stirn gerundet)							Tapered Torpedo / Konus mit Torpedospitze			
											
n	R 198-012	R 198-018	R 198-025	R 199-012		R 199-018	R 199-022			R 297-014	R 297-016
c	R 198-012 c	R 198-018 c	R 198-025 c	R 199-012 c	R 199-016 c	R 199-018 c	R 199-022 c	R 200-016 c	R 297-012 c	R 297-014 c	R 297-016 c
f	R 198-012 f	R 198-018 f	R 198-025 f	R 199-012 f		R 199-018 f	R 199-022 f		R 297-012 f	R 297-014 f	R 297-016 f
sc			R 198-025 sc	R 199-012 sc		R 199-018 sc	R 199-022 sc	R 200-016 sc			

RETARD	Tapered Torpedo / Konus mit Torpedospitze								
									
n	R 298-014	R 298-016	R 298-018	R 298-020	R 298-022	R 299-014	R 299-016	R 299-018	R 299-022
c	R 298-014 c	R 298-016 c	R 298-018 c	R 298-020 c	R 298-022 c	R 299-014 c	R 299-016 c	R 299-018 c	R 299-022 c
f	R 298-014 f	R 298-016 f	R 298-018 f	R 298-020 f	R 298-022 f	R 299-014 f	R 299-016 f	R 299-018 f	R 299-022 f

SVRDLA SE PRODAJU U BLISTERU 3KOM  
CIJENA ZA 3 KOMADA

20,85€ + PDV

**26,06€**

17,72€ + PDV

**22,15€**

CIJENA S UKLJUČENIM PDV-OM

-15%

# WILOFA DIJAMANTNA SVRDLA

RETARD	Cavity Ball / Kavitäten-Kugel				Cavity Pear / Kavitäten-Birne			Egg / Ei			Football / Football
	n	R 001-014		R 001-018	R 001-021	R 234-012	R 234-014	R 234-016	R 234-018	R 277-020	R 277-023
c		R 001-016 c	R 001-018 c	R 001-021 c	R 234-012 c	R 234-014 c	R 234-016 c	R 234-018 c	R 277-020 c	R 277-023 c	R 271-023 c
f					R 234-012 f	R 234-014 f	R 234-016 f		R 277-020 f	R 277-023 f	R 271-023 f
sc					R 234-012 sc	R 234-014 sc	R 234-016 sc	R 234-018 sc			

RETARD	Cylinder with rounded edge / Zylinder (Kanten gerundet)				Flame / Flamme							
	n	R 156-012	R 156-014	R 157-012	R 157-014	R 158-012	R 158-014	R 250-012	R 250-014	R 250-016		
c	R 156-012 c	R 156-014 c	R 157-012 c	R 157-014 c	R 158-012 c	R 158-014 c	R 250-012 c	R 250-014 c	R 250-016 c	R 251-016 c		
f	R 156-012 f	R 156-014 f	R 157-012 f	R 157-014 f	R 158-012 f	R 158-014 f	R 250-012 f	R 250-014 f	R 250-016 f			
sc	R 156-012 sc	R 156-014 sc	R 157-012 sc	R 157-014 sc	R 158-012 sc	R 158-014 sc	R 250-012 sc	R 250-014 sc	R 250-016 sc	R 251-016 sc		

RETARD	Round End Cylinder / Rundkopf-Zylinder						Bud / Ei mit Spitze				
	n	R 140-012	R 140-014	R 141-010	R 141-012	R 141-014	R 141-016	R 142-012	R 142-014	R 142-016	R 274-020
c	R 140-012 c	R 140-014 c	R 141-010c	R 141-012 c	R 141-014 c	R 141-016 c	R 142-012 c	R 142-014 c	R 142-016 c		
f	R 140-012 f	R 140-014 f	R 141-010 f	R 141-012 f	R 141-014 f	R 141-016 f	R 142-012 f	R 142-014 f	R 142-016 f	R 274-020 f	
sc	R 140-012 sc	R 140-014 sc	R 141-010 sc	R 141-012 sc	R 141-014 sc	R 141-016 sc	R 142-012 sc	R 142-014 sc	R 142-016 sc		

SVRDLA SE PRODAJU U BLISTERU 3KOM  
CIJENA ZA 3 KOMADA

20,85€ + PDV

**26,06€**

17,72€ + PDV

**22,15€**

CIJENA S UKLJUČENIM PDV-OM

-15%

PLAVA SVRDLA NEMA U PONUDI



## WILOFA REZAČ CIRKONA

Pakiranje od 3 komada / cijena po komadu

7,94€ + PDV

**9,93€**

6,35€ + PDV

**7,95€**

CIJENA S UKLJUČENIM PDV-OM

-20%

# KARBIDNA SVRDLA

## GOLD TURBO CARBIDI



Karbidna svrdla sa zaštitnim slojem od cirkon-nitrita. Pakiranje od 3 komada

KLASIČNI OBLIK	0.10	0.12	0.14	0.16	0.18	0.21	0.23
PRODUŽENI OBLIK	0.10L	0.12L	0.14L	0.16L	0.18L	0.21L	0.23L

Cijena po paketu, klasični oblik

~~25,95€ + PDV~~

~~32,44€~~

20,76€ + PDV

**25,95 €**

CIJENA S UKLJUČENIM PDV-OM

-20%

Cijena po paketu, produženi oblik

~~29,85€ + PDV~~

~~37,31€~~

23,88€ + PDV

**29,85 €**

CIJENA S UKLJUČENIM PDV-OM

-20%

## X - CUT TURBO CARBIDI



Višestruko nazubljeni, vrhunska kvaliteta. Pakiranje od 3 komada

KLASIČNI OBLIK	0.10	0.12	0.14	0.16	0.18	0.21	0.23
PRODUŽENI OBLIK	0.10L	0.12L	0.14L	0.16L	0.18L	0.21L	0.23L

Cijena po paketu, klasični oblik

~~22,51€ + PDV~~

~~28,14€~~

18,00€ + PDV

**22,51€**

CIJENA S UKLJUČENIM PDV-OM

-20%

Cijena po paketu, produženi oblik

~~27,00€ + PDV~~

~~33,75€~~

21,60€ + PDV

**27,00€**

CIJENA S UKLJUČENIM PDV-OM

-20%

## ECONOMY LINE CARBIDI

**ELA**

**CARBIDE BUR  
ROUND**



Pakiranje od 6 komada

KLASIČNI OBLIK	0.10	0.12	0.14	0.16	0.18	0.21	0.23
PRODUŽENI OBLIK	0.10L	0.12L	0.14L	0.16L	0.18L	0.21L	0.23L

Cijena po paketu klasičnih i produženih

~~12,00€ + PDV~~

~~15,00€~~

9,60€ + PDV

**12,00€**

CIJENA S UKLJUČENIM PDV-OM

-20%

## REZAČ MOSTOVA I KRUNICA

**TRI-HAWK**  
FOR THE BUR CONNOISSEUR



**10 + 5  
gratis!**

~~104,25€ + PDV~~

~~130,31€~~

6,95€ + PDV

**86,88€**

CIJENA S UKLJUČENIM PDV-OM

EVE DIACOMP PLUS 1KOM U PAKIRANJU

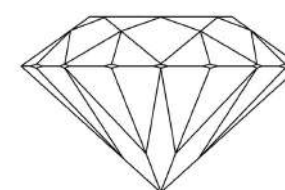

-20%

KOMPOZIT, HIBRIDNA KERAMIKA, 3D ISPIS HIBRIDNOG MATERIJALA



DT-DCP14m	DT-DCP10m	DCP-OFm	DCP-W11m
14 X 1,6	11 X 1,6	5,5 X 8,8	3 X 7,5
19,73 € 15,79 €	18,50 € 14,80 €	15,27 € 12,22 €	12,50 € 10,00 €



DT-DCP14f	DT-DCP10f	DCP-OFF	DCP-W11f
14 X 1,6	11 X 1,6	5,5 X 8,8	3 X 7,5
19,73 € 15,79 €	18,50 € 14,80 €	15,27 € 12,22 €	12,50 € 10,00 €



DCP1m	DCP2m	DCP3m	DCP-W2Bm	DCP-FG1m
4 X 10	10 X 2,5	6 X 7,5	5 X 10	3 X 6,5
13,31 € 10,65 €	13,31 € 10,65 €	13,31 € 10,65 €	13,31 € 10,65 €	8,88 € 7,10 €



DCP1f	DCP2f	DCP3f	DCP-W2Bf	DCP-FG1f
4 X 10	10 X 2,5	6 X 7,5	5 X 10	3 X 6,5
13,31 € 10,65 €	13,31 € 10,65 €	13,31 € 10,65 €	13,31 € 10,65 €	8,88 € 7,10 €

MEDIUM Predpoliranje

3.000 - 8.000 min-1  
max. 20.000 min-1

FINE Visoki sjaj poliranje

3.000 - 8.000 min-1  
max. 20.000 min-1

EVE DIACOMP PLUS - SET

KOMPOZIT, HIBRIDNA KERAMIKA, 3D ISPIS HIBRIDNOG MATERIJALA



3.000 - 8.000 min-1  
max. 20.000 min-1



DCP-W2Bf	DCP3f	DCP-OFF	DCP2f
5 X 10	6 X 7,5	5,5 X 8,8	10 X 2,5

FINE Visoki sjaj poliranje



DCP-W2Bm	DCP3m	DCP-OFm	DCP2m
5 X 10	6 X 7,5	5,5 X 8,8	10 X 2,5

MEDIUM Predpoliranje

77,14 € + PDV **96,43 €**  
61,71 € + PDV **77,14 €**  
CIJENA S UKLJUČENIM PDV-OM

**EVE DIACOMP ULTRA - 1 KOM U PAKIRANJU**  
**ONE STEP TEHNIKA ZA KOMPOSITE I HIBRID KERAMIKU**

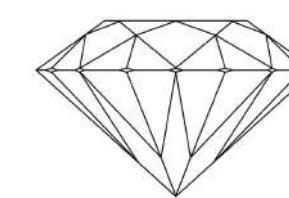

**-20%**

<b>DCU-W11</b>	<b>DCU1</b>	<b>DCU2</b>	<b>DCU3</b>	<b>DCU-FG1</b>
<b>14 X 1,6</b>	<b>11 X 1,6</b>	<b>5,5 X 8,8</b>	<b>3 X 7,5</b>	<b>3 X 7,5</b>
9,67€ 7,74 €	14,88€ 11,90 €	14,88€ 11,90 €	14,88€ 11,90 €	9,67€ 7,74€



**Predpoliranje: Jači pritisak**  
**Visoki sjaj poliranje: Smanjeni pritisak**

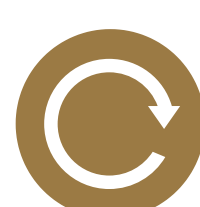

**3.000 - 10.000 min-1**  
**max. 20.000 min-1**

**EVE DIACOMP ULTRA - SET**

**ONE STEP TEHNIKA ZA KOMPOSITE, HIBRID KERAMIKU**



**Predpoliranje: Jači pritisak**  
**Visoki sjaj poliranje: Smanjeni pritisak**

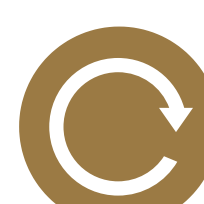

**3.000 - 10.000 min-1**  
**max. 20.000 min-1**



41,26 € + PDV	<b>51,57 €</b>
33,01 € + PDV	<b>41,26 €</b>
CIJENA S UKLJUČENIM PDV-OM	

<b>DCU-W11</b>	<b>DCU1</b>	<b>DCU2</b>	<b>DCU3</b>
<b>14 X 1,6</b>	<b>11 X 1,6</b>	<b>5,5 X 8,8</b>	<b>3 X 7,5</b>

# DIAPOL- 1 KOM U PAKIRANJU

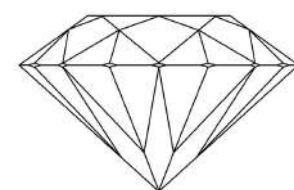

FELDSPAT KERAMIKA, LITIJ DISILIKAT, CIRKON,

**-20%**



DT-W14Dg	OF-Dg	W11Dg	W16Dg	W17Dg	W18Dg	W2Dg	W8Dg	FG1Dg
14 X 1,6	5,5 X 8,8	3 X 7,5	4 X 10	6 X 7,5	10 X 2,5	4 X 13	11 X 2	3 X 6,5
19,73 € 15,79 €	15,28 € 12,22 €	6,76 € 5,41 €	13,13 € 10,50 €	13,13 € 10,50 €	13,13 € 10,50 €	18,51 € 14,81 €	18,51 € 14,81 €	8,45 € 6,76 €

7.000 - 12.000 min-1  
\* 3.000 - 8.000 min-1  
max. 20.000 min-1  
**COARSE** Zaglađivanje



DT-W14Dmf	OF-Dmf	W11Dmf	W16Dmf	W17Dmf	W18Dmf	W2Dmf	W8Dmf	FG1Dmf
14 X 1,6	5,5 X 8,8	3 X 7,5	4 X 10	6 X 7,5	10 X 2,5	4 X 13	11 X 2	3 X 6,5
19,73 € 15,79 €	15,28 € 12,22 €	6,76 € 5,41 €	13,13 € 10,50 €	13,13 € 10,50 €	13,13 € 10,50 €	18,51 € 14,81 €	18,51 € 14,81 €	8,45 € 6,76 €

7.000 - 12.000 min-1  
\* 3.000 - 8.000 min-1  
max. 20.000 min-1  
**MEDIUM** Predpoliranje



DT-W14D	OF-D	W11D	W16D	W17D	W18D	W2D	W8D	FG1D
14 X 1,6	5,5 X 8,8	3 X 7,5	4 X 10	6 X 7,5	10 X 2,5	4 X 13	11 X 2	3 X 6,5
19,73 € 15,79 €	15,28 € 12,22 €	6,76 € 5,41 €	13,13 € 10,50 €	13,13 € 10,50 €	13,13 € 10,50 €	18,51 € 14,81 €	18,51 € 14,81 €	8,45 € 6,76 €

7.000 - 12.000 min-1  
\* 3.000 - 8.000 min-1  
max. 20.000 min-1  
**FINE** Visoki sjaj poliranje

# DIAPOL - SET

FELDSPAR CERAMIC, LITHIUM DISILICATE, ZIRCONIA



4 X 10, 5,5 X 8,8, 6 X 7,5, 10 X 2,5

7.000 - 12.000 min-1  
\* 3.000 - 8.000 min-1  
max. 20.000 min-1  
**COARSE** Zaglađivanje



4 X 10, 5,5 X 8,8, 6 X 7,5, 10 X 2,5

7.000 - 12.000 min-1  
\* 3.000 - 8.000 min-1  
max. 20.000 min-1  
**MEDIUM** Predpoliranje



4 X 10, 5,5 X 8,8, 6 X 7,5, 10 X 2,5







7.000 - 12.000 min-1  
\* 3.000 - 8.000 min-1  
max. 20.000 min-1  
**FINE** Visoki sjaj poliranje





122,82 € + PDV      153,52 €  
98,26 € + PDV      122,82 €  
CIJENA S UKLJUČENIM PDV-OM





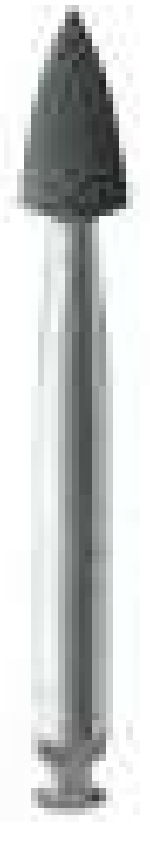
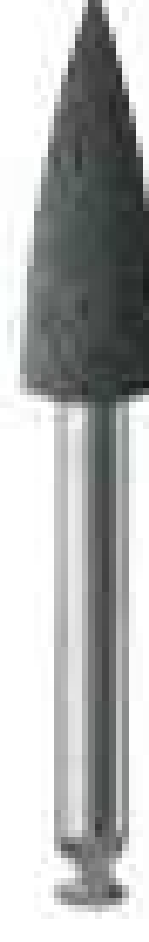
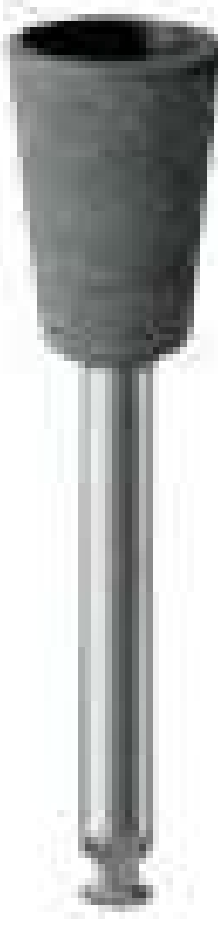
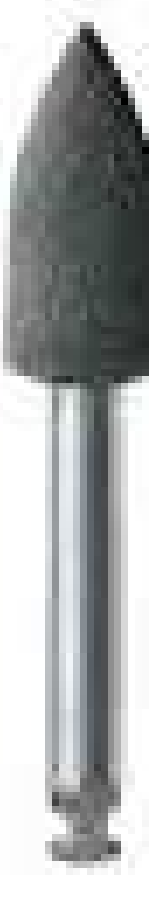

# UNIVERSAL - 10 KOM U PAKIRANJU

KOMPOZIT, FELDSPAT KERAMIKA, AMALGAM, ZLATO

**-20%**

					
<b>R12</b>	<b>L13</b>	<b>K11</b>	<b>K12</b>	<b>K15</b>	<b>76RA</b>
<b>12 X 2</b>	<b>13 X 2,5</b>	<b>11 X 6</b>	<b>12 X 7</b>	<b>15 X 9</b>	<b>5</b>
<b>10,79 €</b> <b>8,63 €</b>	<b>10,79 €</b> <b>8,63 €</b>	<b>10,79 €</b> <b>8,63 €</b>	<b>10,79 €</b> <b>8,63 €</b>	<b>10,79 €</b> <b>8,63 €</b>	<b>5,81 €</b> <b>4,65 €</b>









								
<b>W11</b>	<b>W1</b>	<b>W2</b>	<b>W2B</b>	<b>W4</b>	<b>AF2K</b>	<b>AF1</b>	<b>AF3K</b>	<b>AF7</b>
<b>3 X 7,5</b>	<b>5,5 X 15</b>	<b>4,5 X 12</b>	<b>5 X 10</b>	<b>5 X 16</b>	<b>3 X 6</b>	<b>4 X 12</b>	<b>6,5 X 9,5</b>	<b>5 X 10</b>
<b>31,25 €</b> <b>25,00 €</b>	<b>31,25 €</b> <b>25,00 €</b>	<b>31,25 €</b> <b>25,00 €</b>	<b>31,25 €</b> <b>25,00 €</b>	<b>31,25 €</b> <b>25,00 €</b>	<b>31,25 €</b> <b>25,00 €</b>	<b>31,25 €</b> <b>25,00 €</b>	<b>31,25 €</b> <b>25,00 €</b>	<b>31,25 €</b> <b>25,00 €</b>

						
<b>W5</b>	<b>W6</b>	<b>W7</b>	<b>W8</b>	<b>W9</b>	<b>GH3K</b>	<b>GH7</b>
<b>9 X 8,5</b>	<b>8 X 7</b>	<b>7 X 10</b>	<b>11 X 2</b>	<b>11 X 2,5</b>	<b>6,5 X 9,5</b>	<b>5 X 10</b>
<b>31,25 €</b> <b>25,00 €</b>	<b>31,25 €</b> <b>25,00 €</b>	<b>31,25 €</b> <b>25,00 €</b>	<b>31,25 €</b> <b>25,00 €</b>	<b>31,25 €</b> <b>25,00 €</b>	<b>31,25 €</b> <b>25,00 €</b>	<b>31,25 €</b> <b>25,00 €</b>



# UNIVERSAL - SET

KOMPOZIT, FELDSPAT KERAMIKA, LITIJ DISILIKAT, CIRKON



			
<b>W11</b>	<b>W1</b>	<b>W2</b>	<b>W2B</b>
<b>3 X 7,5</b>	<b>5,5 X 15</b>	<b>4,5 X 12</b>	<b>5 X 10</b>
			
<b>W5</b>	<b>W7</b>	<b>W8</b>	<b>W9</b>
<b>9 X 8,5</b>	<b>7 X 10</b>	<b>11 X 2</b>	<b>11 X 2,5</b>

17,03 € + PDV **21,29 €**  
 13,62 € + PDV **17,03 €**  
 CIJENA S UKLJUČENIM PDV-OM

 MEDIUM Zaglađivanje  
 7.000 - 10.000 min-1  
 max. 20.000 min-1

## DIABRUSH - 1 KOM U PAKIRANJU

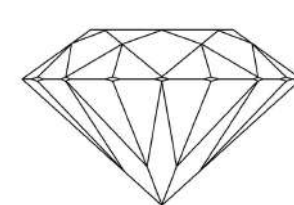

KOMPOZIT, FELDSPAT KERAMIKA

-20%



WTD1	WZD1	WSD1
6 X 5,5	4 X 6,5	4 X 6,5
13,13 € 10,50 €	13,13 € 10,50 €	13,13 € 10,50 €

- FINE: Visoki sjaj poliranje
- TVRDOĆA: medium
- ⌚ max. 10.000 min-1

## DIABRUSH- 10 KOM U PAKIRANJU

KOMPOZIT, FELDSPAT KERAMIKA



WTH	WZH	WSH	WTM	WZM	WSM	WTS	WZS	WSS
6 X 5,5	4 X 6,5	4 X 6,5	6 X 5,5	4 X 6,5	4 X 6,5	6 X 5,5	4 X 6,5	4 X 6,5
20,59 € 16,47 €	20,59 € 16,47 €	20,59 € 16,47 €	18,75 € 15,00 €	18,75 € 15,00 €	18,75 € 15,00 €	20,59 € 16,47 €	20,59 € 16,47 €	20,59 € 16,47 €

- TVRDOĆA hard
- TVRDOĆA medium
- TVRDOĆA super meke
- ⌚ max. 10.000 min-1
- ⌚ max. 10.000 min-1
- ⌚ max. 10.000 min-1

## FIBERWHEELS- 10 KOM U PAKIRANJU

AKRILAT, NEM LEGURE, TERMOFORMNE TEHNOLOGIJE, ZLATO



- GRUBE Zaglađivanje
- MEDIUM Predpoliranje
- FINE Poliranje

FI-H26g	FI-H26m	FI-H26f
25 X 11	25 X 11	25 X 11
30,26 € 24,21 €	30,26 € 24,21 €	30,26 € 24,21 €





# TECHNIK - 1 KOM U PAKIRANJU

AKRILAT, TERMOFORMNE TEHNOLOGIJE

-20%



H330K	H332K	H334K	H336K	H338	H340
12 X 22	10 X 20	10 X 24	15 X 17	5,5 X 16	6,5 X 17
7,50 € 6,00 €	7,50 € 6,00 €	7,50 € 6,00 €	7,50 € 6,00 €	6,88 € 5,50 €	6,88 € 5,50 €

GRUBE Zaglađivanje

5.000 - 7.000 min-1



H330Km	H332Km	H334Km	H336Km	H338m	H340m
12 X 22	10 X 20	10 X 24	15 X 17	5,5 X 16	6,5 X 17
7,50 € 6,00 €	7,50 € 6,00 €	7,50 € 6,00 €	7,50 € 6,00 €	6,88 € 5,50 €	6,88 € 5,50 €

MEDIUM Predpoliranje

5.000 - 7.000 min-1



H330Kf	H332Kf	H334Kf	H336Kf	H338f	H340f
12 X 22	10 X 20	10 X 24	15 X 17	5,5 X 16	6,5 X 17
7,50 € 6,00 €	7,50 € 6,00 €	7,50 € 6,00 €	7,50 € 6,00 €	6,88 € 5,50 €	6,88 € 5,50 €

FINE Poliranje

5.000 - 7.000 min-1

# TECHNIK - SET HP125

AKRILAT, TERMOFORMNE TEHNOLOGIJE, ZLATO



MEDIUM Predpoliranje

FINE Visoki sjaj poliranje

5.000 - 7.000 min-1

38,93 € + PDV **48,66 €**

31,14 € + PDV **38,93 €**

CIJENA S UKLJUČENIM PDV-OM

# CERASTONE - 10 KOM U PAKIRANJU

KOMPOZIT, FELDSPAT KERAMIKA, AMALGAM, ZLATO

**-20%**



CSG-RA-601    CSG-RA-645    CSG-RA-649    CSG-RA-661    CSG-RA-638    CSG-RA-666

**3 X 3**            **3 X 7**            **2,5 X 6**            **2,5 X 7**            **2,5 X 6**            **2,5 X 6,5**

31,25€ / 25,00 €    31,25€ / 25,00 €    31,25€ / 25,00 €    31,25€ / 25,00 €    31,25€ / 25,00 €    31,25€ / 25,00 €

12.000 - 30.000 min-1  
 FINE



CSW-RA-601    CSW-RA-645    CSW-RA-649    CSW-RA-661    CSW-RA-638    CSW-RA-666  
CSW-FG-601    CSW-FG-645    CSW-FG-649    CSW-FG-661    CSW-FG-638    CSW-FG-666

**3 X 3**            **3 X 7**            **2,5 X 6**            **2,5 X 7**            **2,5 X 6**            **2,5 X 6,5**

31,25€ / 25,00 €    31,25€ / 25,00 €    31,25€ / 25,00 €    31,25€ / 25,00 €    31,25€ / 25,00 €    31,25€ / 25,00 €

RA-KOLJIČNIK  
FG-TURBINA

12.000 - 30.000 min-1  
 EXTRAFINE

# DIASYNT PLUS - 1 KOM U PAKIRANJU

FELDSPAT KERAMIKA, LITIJ DISILIKAT, CIRKON

MEDIUM 8.000 - 12.000 min-1

COARSE 8.000 - 12.000 min-1



DYP-W11m    DYP-W13m    DYP-W9m

DYP-W11g    DYP-W13g    DYP-W9g

**3 X 7,5**            **4 X 10**            **11,5 X 3**

**3 X 7,5**            **4 X 10**            **11,5 X 3**

13,31€ / 10,65 €    22,53€ / 18,02 €    29,36€ / 23,49 €

13,31€ / 10,65 €    22,53€ / 18,02 €    29,36€ / 23,49 €



### Perforirane gornja čeljust

- Small 107-361
- Medium 107-362
- Large 107-363



### Pune gornja čeljust

- Small 107-381
- Medium 107-382
- Large 107-383



### BORDERLOCK ŽLICE

### Perforated Upper Jaw

- Small 107-004
- Medium 107-003
- Large 107-002
- Extra Large 107-001



### Perforirane donja čeljust

- Small 107-351
- Medium 107-352
- Large 107-353



### Pune donja čeljust

- Small 107-371
- Medium 107-372
- Large 107-373



### Perforated Lower Jaw

- Small 107-010
- Medium 107-009
- Large 107-008
- Extra Large 107-007



### Perforirane bezuba čeljust

- Small 107-401
- Medium 107-402
- Large 107-403



### Solid Lower Jaw

- Small 107-411
- Medium 107-412
- Large 107-413



### Solid Lower Jaw

- Small 107-045
- Medium 107-044
- Large 107-043
- Extra Large 107-042



### Perforated Lower Jaw

- Small 107-391
- Medium 107-392
- Large 107-393



### Solid Upper Jaw

- Small 107-421
- Medium 107-422
- Large 107-423



### Solid Upper Jaw

- Small 107-040
- Medium 107-039
- Large 107-038
- Extra Large 107-037

10,50€ + PDV

~~13,13€~~

8,40€ + PDV

**10,50€**

CIJENA S UKLJUČENIM PDV-OM

-20%

## BORDERLOCK ŽLICE



### Rimlock perforirane gornje

- Small 107-095
- Medium 107-094
- Large 107-093
- Extra Large 107-092



### Rimlock perforirane donje

- Small 107-099
- Medium 107-098
- Large 107-097
- Extra Large 107-096



### Rimlock puna donja

- Small 107-113
- Medium 107-112
- Large 107-111
- Extra Large 107-110

## BORDER LOCK SCHEINEMAKERS SET



265,00€ + PDV ~~331,25€~~

212,00€ + PDV **265,00€**

CIJENA S UKLJUČENIM PDV-OM

-20%



### Rimlock puna donje

- Small 107-109
- Medium 107-108
- Large 107-107
- Extra Large 107-106

~~10,50€ + PDV~~

~~13,13€~~

8,40€ + PDV

**10,50€**

CIJENA S UKLJUČENIM PDV-OM

-20%

107-1133



~~10,50€ + PDV~~

~~13,13€~~

8,40€ + PDV

**10,50€**

CIJENA S UKLJUČENIM PDV-OM

-20%

## SET PERFORIRANIH ŽLICA

### Perforirane donja čeljust

- Small 107-010
- Medium 107-009
- Large 107-008
- Extra Large 107-007

### Perforirane donja čeljust

- Small 107-010
- Medium 107-009
- Large 107-008
- Extra Large 107-007

**100-005A**  
**GORNJA PREMOLARNA**



**100-001A**  
**GORNJA INCIZALNA**



**100-007A**  
**DONJA PREMOLARNA**



**100-010A**  
**GORNJA MOLARNA, DESNO**



**100-011A**  
**GORNJA MOLARNA, LIJEVO**



**100-017A**  
**DONJA MOLARNA**



**100-029A**  
**DONJA KORIJENSKA**



**100-042A**  
**GORNJA KORIJENSKA**



**100-055A**  
**GORNJA UMNJAČAK**



**100-070A**  
**DONJA UMNJAČAK**



66,00€ + PDV

~~82,50€~~

52,80€ + PDV

**66,00€**

CIJENA S UKLJUČENIM PDV-OM

-20%

# INSTRUMENTI

## INTRALIGAMENTARNA KARPULA



100-288  
1.8 ml

∅

-20%

96,00€ + PDV 120,00€

76,80€ + PDV 96,00€  
CIJENA S UKLJUČENIM PDV-OM

## ASPIRACIJSKA ŠPRICA



100-298  
1.8 ml

-20%

36,00€ + PDV 45,00€

28,80€ + PDV 36,00€  
CIJENA S UKLJUČENIM PDV-OM

## HEIDEMAN ŠPATULA



102-431  
1.5 mm

102-432  
2.0 mm

102-433  
2.5 mm

102-434  
3.0 mm

-20%

10,50€ + PDV 13,13€

8,40€ + PDV 10,50€  
CIJENA S UKLJUČENIM PDV-OM

## NABIJAČI



102-302  
1.2/1.6 mm

102-576  
1.4/1.8 mm

102-303  
2.0/2.5 mm

102-578  
2.5/3.0 mm

-20%

10,50€ + PDV 13,13€

8,40€ + PDV 10,50€  
CIJENA S UKLJUČENIM PDV-OM

## INSTRUMENTI ZA OBLIKOVANJE KOMPOZITA



102-637  
Markley  
0.6/1.1 mm

-20%

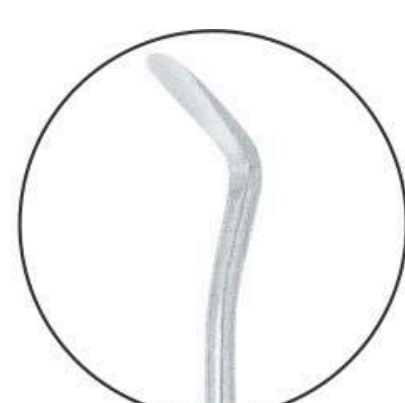

102-464  
Frahm  
2.6 mm

-20%



102-403  
Woodson  
2.8/3.0 mm

-20%

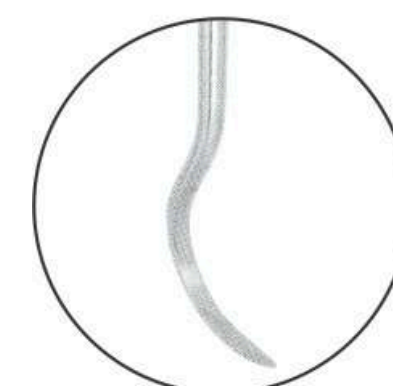

102-739  
Wiland

-20%

10,50€ + PDV 13,13€

8,40€ + PDV 10,50€  
CIJENA S UKLJUČENIM PDV-OM

## INSTRUMENTI ZA RETRAKCIJSKI KONAC

102-1103  
2.8 mm

-20%

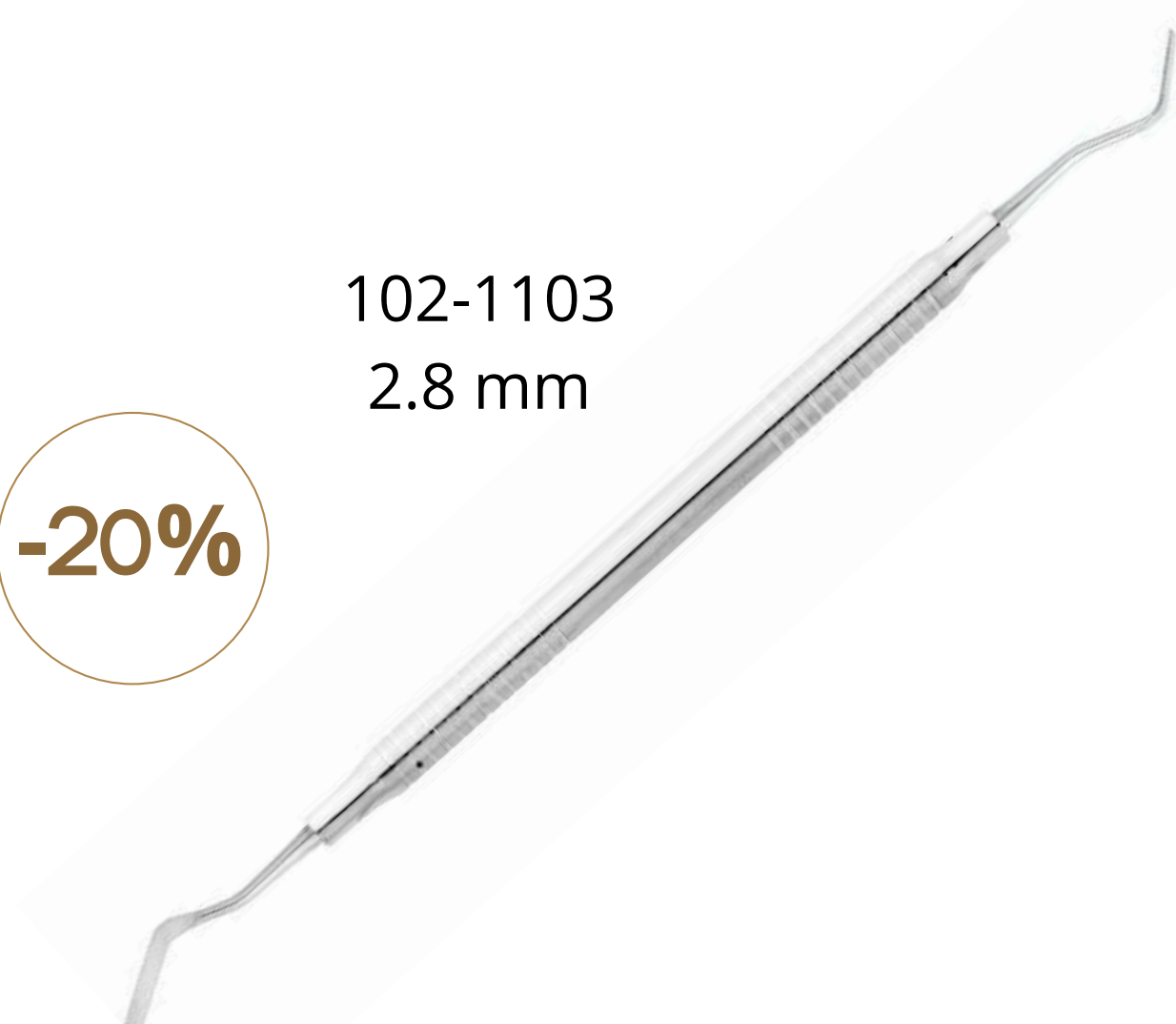

102-1105  
2.8 mm

-20%

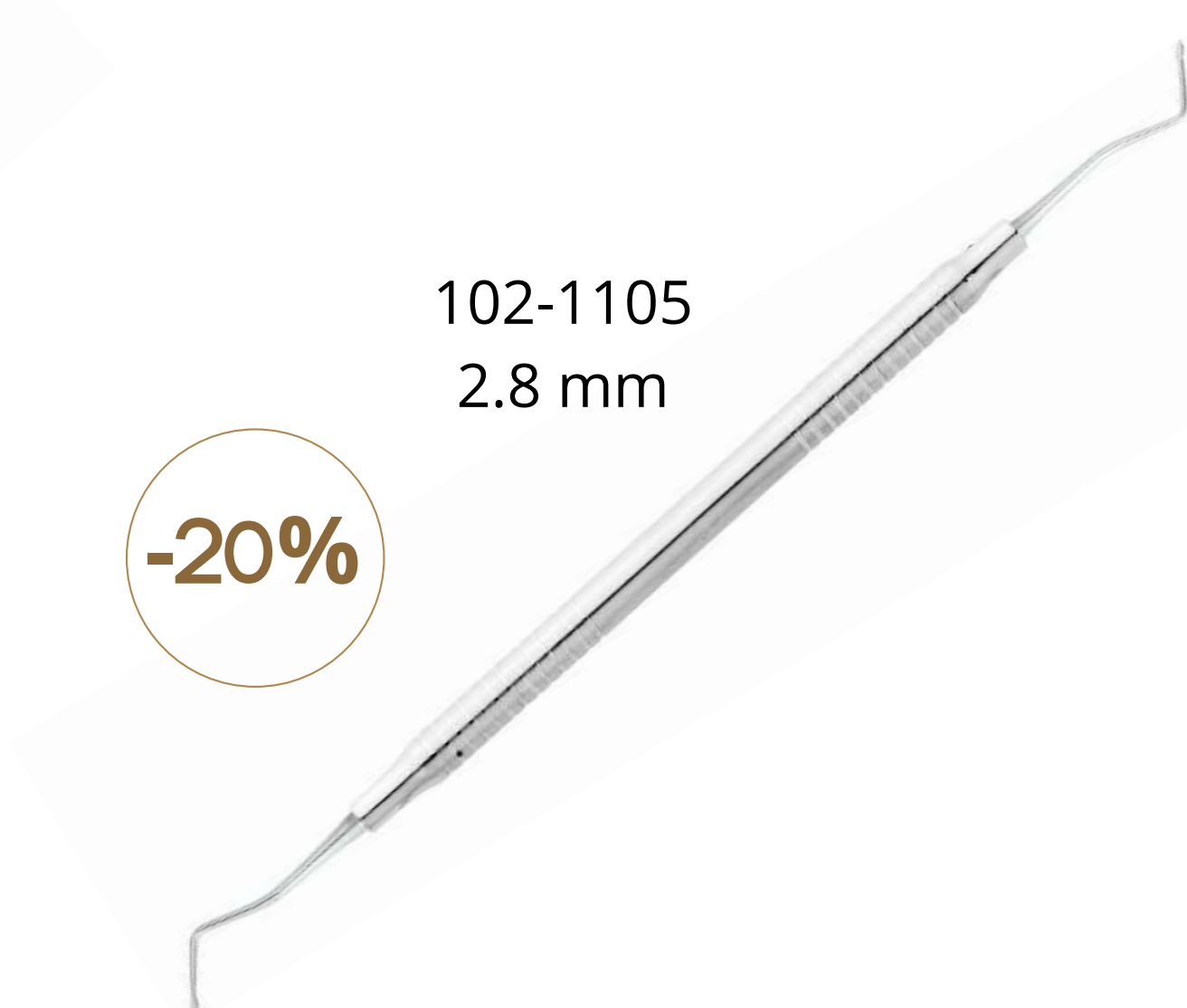

10,50€ + PDV 13,13€

8,40€ + PDV 10,50€  
CIJENA S UKLJUČENIM PDV-OM



101-194  
Desni  
1.3 mm

101-193  
Lijevi  
1.3 mm

-20%

27,00€ + PDV 33,75€

21,60€ + PDV 27,00€  
CIJENA S UKLJUČENIM PDV-OM

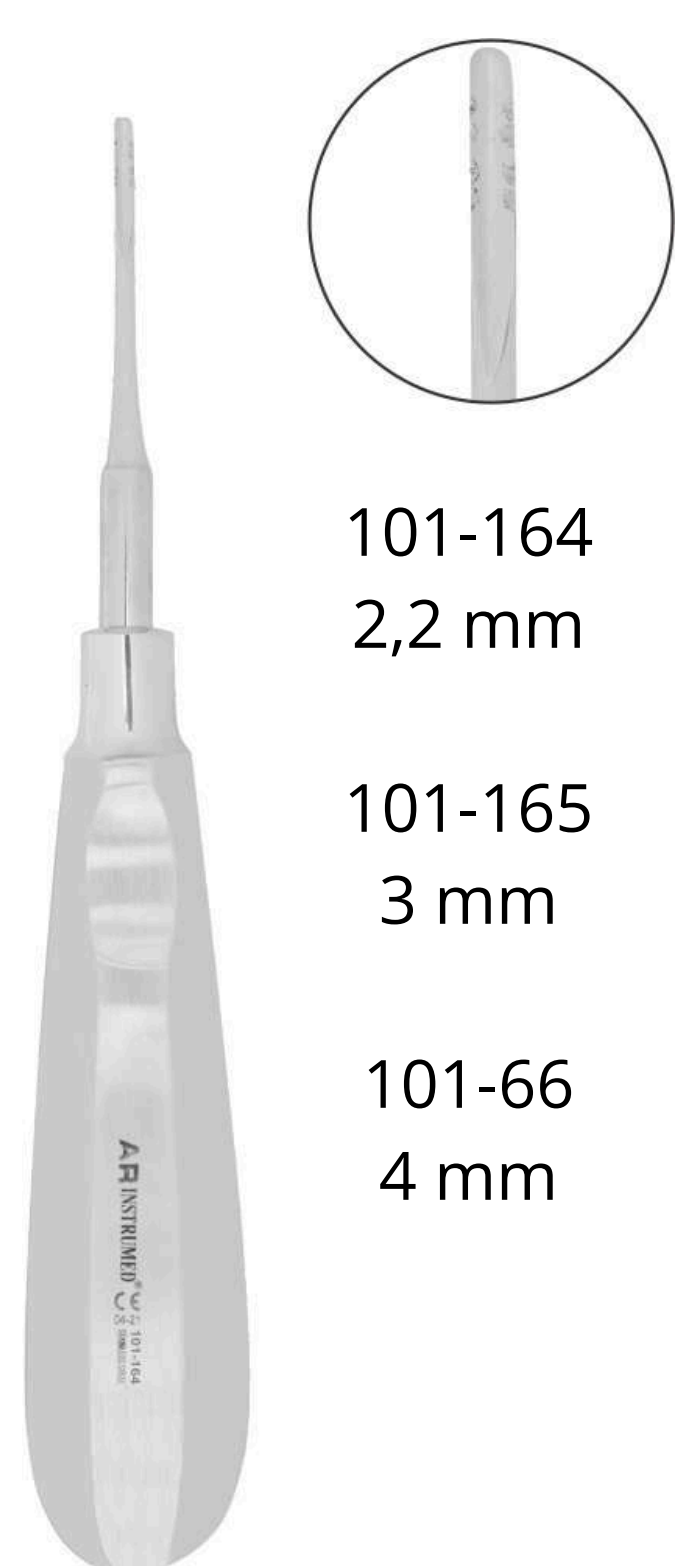

101-164  
2,2 mm

101-165  
3 mm

101-66  
4 mm



101-168  
Desni  
4 mm

101-167  
Lijevi  
4 mm

-20%

18,00€ + PDV 22,50€

14,40€ + PDV 18,00€  
CIJENA S UKLJUČENIM PDV-OM



101-097  
Bein  
3 mm



101-116  
Desni  
4 mm

101-119  
Lijevi  
4 mm

101-117  
Ravni  
4mm

## PINCETE



102-042  
Karbida kirurška  
pinceta  
Adson  
12 cm

-20%

54,00€ + PDV 67,50€

43,20€ + PDV 54,00€  
CIJENA S UKLJUČENIM PDV-OM



102-104  
Kirurška pinceta  
12 cm

-20%

8,10€ + PDV 10,13€

6,48€ + PDV 8,10€  
CIJENA S UKLJUČENIM PDV-OM



102-089  
Atraumatska  
pinceta ravna  
15 cm

-20%

18,00€ + PDV 22,50€

14,40€ + PDV 18,00€  
CIJENA S UKLJUČENIM PDV-OM



102-051-1  
Semken-  
Taylor ravna  
12 cm

-20%

8,10€ + PDV 10,13€

6,48€ + PDV 8,10€  
CIJENA S UKLJUČENIM PDV-OM



102-059  
Meriam  
16 cm

102-059N  
Meriam  
Ne magnetna  
16cm

-20%

12,60€ + PDV 15,75€

10,80€ + PDV 12,60€  
CIJENA S UKLJUČENIM PDV-OM

## RETRAKTORI

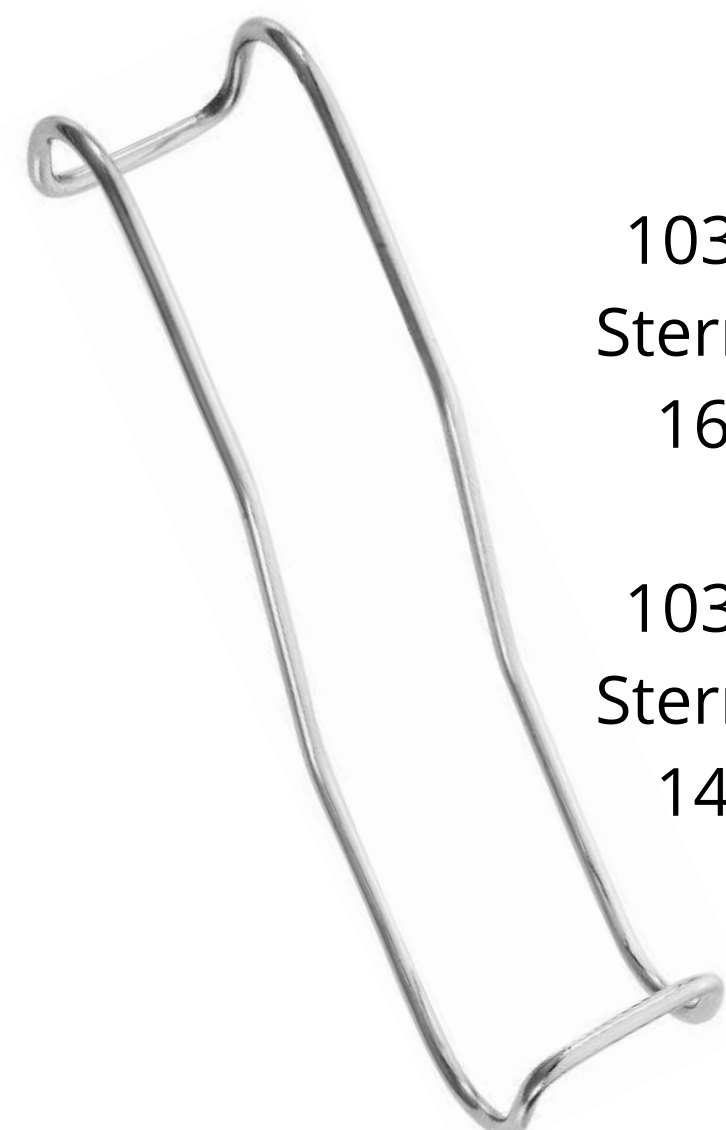

103-182  
Sternberg  
16 cm

103-182  
Sternberg  
14 cm

-20%

18,00€ + PDV 22,50€

14,40€ + PDV 18,00€  
CIJENA S UKLJUČENIM PDV-OM

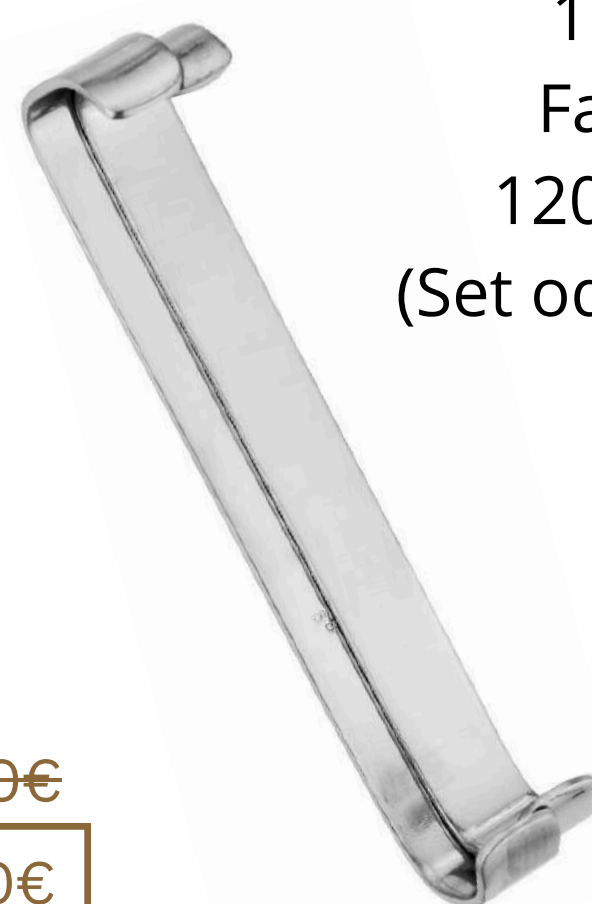

103-037  
Farabuef  
120x12 mm  
(Set od 2 komada)

-20%

15,45€ + PDV 19,32€

12,36€ + PDV 15,45€  
CIJENA S UKLJUČENIM PDV-OM

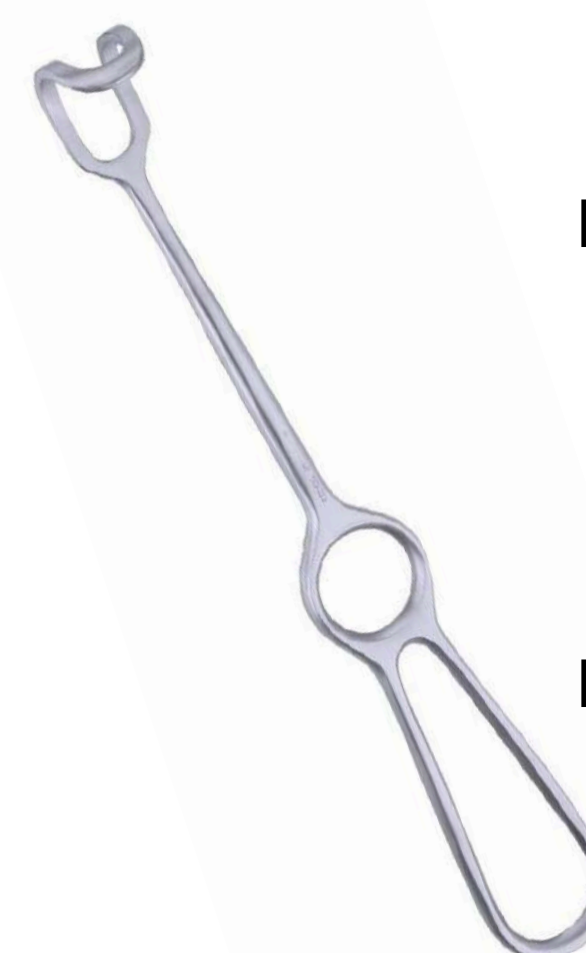

103-220  
Miccdorpf  
20x14 mm  
21 cm

103-221  
Miccdorpf  
20x22 mm  
23 cm

-20%

30,00€ + PDV 37,50€

24,00€ + PDV 30,00€  
CIJENA S UKLJUČENIM PDV-OM

# INSTRUMENTI

## SONDE

-20%



10,50€ + PDV 13,12€  
8,40€ + PDV 10,50€  
CIJENA S UKLJUČENIM PDV-OM

## PAROSONDE

-20%



11,40€ + PDV 14,25€  
9,12€ + PDV 11,40€  
CIJENA S UKLJUČENIM PDV-OM

## KIRETE

102-900S  
Gracey  
sa silikonskom  
drškom



-20%

54,00€ + PDV 67,50€  
43,20€ + PDV 54,00€  
CIJENA S UKLJUČENIM PDV-OM

102-900  
Gracey



102-815  
Hemingway  
2,5 mm



102-816  
Hemingway  
3,0 mm

102-817  
Hemingway  
3,5 mm

-20%

11,40€ + PDV 14,25€  
9,12€ + PDV 11,40€  
CIJENA S UKLJUČENIM PDV-OM

102-818  
Lucas  
2,0 mm



102-819  
Lucas  
2,5 mm

102-220  
Lucas  
3,0 mm

102-821  
Lucas  
3,5 mm

102-821-1  
Lucas  
4 mm

102-900G  
Gracey  
karbidna  
kireta



-20%

27,00€ + PDV 33,75€  
21,60€ + PDV 27,00€  
CIJENA S UKLJUČENIM PDV-OM



## SINUS LIFT

-20%

106-159-2

106-159-1



21,00€ + PDV 26,25€

16,80€ + PDV 21,00€  
CIJENA S UKLJUČENIM PDV-OM

-20%

## RASPATORIJ

106-050  
G24, TITAN  
4/4 mm



19,20€ + PDV 24,00€

15,36€ + PDV 19,20€  
CIJENA S UKLJUČENIM PDV-OM

-20%

106-114  
Goodman Fox  
6/3 mm



106-049  
Buser  
5/4 mm



19,20€ + PDV 24,00€

15,36€ + PDV 19,20€  
CIJENA S UKLJUČENIM PDV-OM

-20%

## MALI KIRURŠKI SET



107-346

Kazeta za instrumente 185x120x25mm  
Molt kireta 5 mm TITAN  
Molt kireta 3 mm TITAN  
Igodržać 15 cm KARBIDNI  
Kelly škarice 16 cm TITAN

240,00€ + PDV 300,00€

192,00€ + PDV 240,00€  
CIJENA S UKLJUČENIM PDV-OM

-20%

# INSTRUMENTI

# ŠKARICE

103-051  
Iris zakrivljene  
11 cm

103-049  
Iris ravne  
11.5 cm

10,50€ + PDV 13,13€

8,40€ + PDV 10,50€  
CIJENA S UKLJUČENIM PDV-OM

-20%



103-093  
Metzenbaum  
ravne  
14.5 cm

12,00€ + PDV 15,00€

9,60€ + PDV 12,00€  
CIJENA S UKLJUČENIM PDV-OM

-20%



109-005  
Karbidne  
Mikro-kirurške  
Castroviejo  
18 cm

135,00€ + PDV 168,75€

108,00€ + PDV 135,00€  
CIJENA S UKLJUČENIM PDV-OM

-20%



# IGLODRŽAČI

# DRŽAČI SKALPELA

103-130-1  
Karbidni  
Mayo Hegar  
15 cm

103-150  
Karbidni  
Castroviejo ravni  
18 cm

106-327  
130 mm

106-334-2  
Držać na kliker

66,00€ + PDV 82,50€

52,80€ + PDV 66,00€  
CIJENA S UKLJUČENIM PDV-OM

-20%



96,00€ + PDV 120,00€

76,80€ + PDV 96,00€  
CIJENA S UKLJUČENIM PDV-OM

-20%



6,60€ + PDV 8,25€

5,28€ + PDV 6,60€  
CIJENA S UKLJUČENIM PDV-OM

-20%



36,00€ + PDV 45,00€

28,80€ + PDV 36,00€  
CIJENA S UKLJUČENIM PDV-OM

-20%



# SKIDAČ KRUNICA

103-248

75,00€ + PDV 93,75€

60,00€ + PDV 75,00€  
CIJENA S UKLJUČENIM PDV-OM

-20%

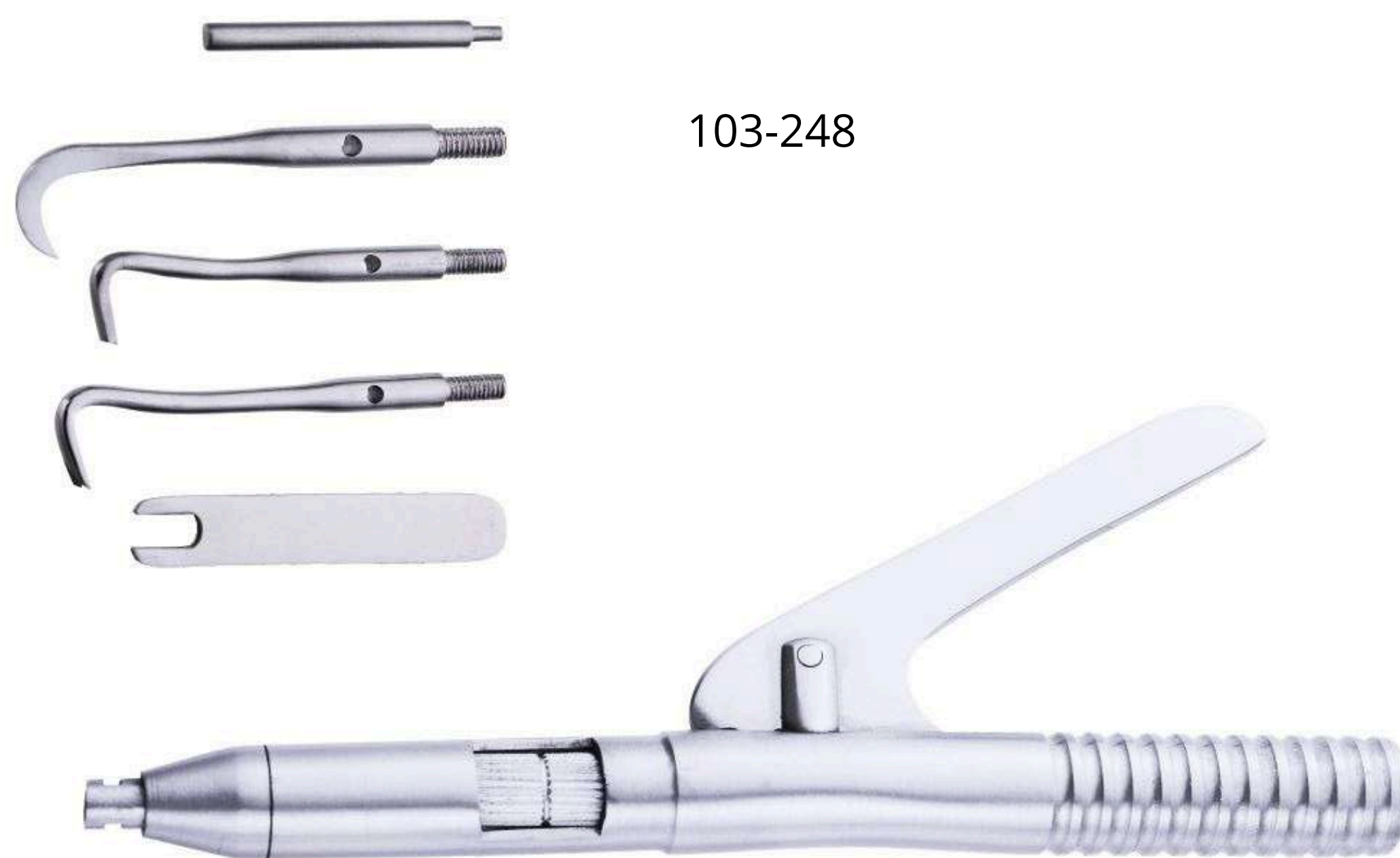

## SET ZA KOFERDAM

110-025-1  
Set za koferdam  
13 kvačica



~~240,00€ + PDV~~ ~~300,00€~~

192,00€ + PDV 240,00€  
CIJENA S UKLJUČENIM PDV-OM

-20%

## LANČIĆ ZA PREGAČE

103-601-B

Dostupne boje:

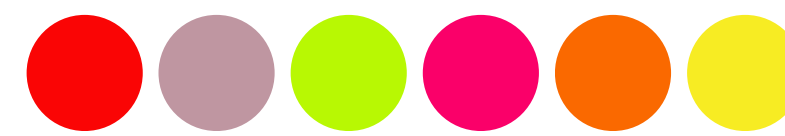

~~7,50€ + PDV~~

~~9,37€~~

6,00€ + PDV

7,50€

CIJENA S UKLJUČENIM PDV-OM

-20%

## POSUDA ZA INSTRUMENTE

107-193-1  
20x15x2 cm



~~18,00€ + PDV~~ ~~22,50€~~

14,40€ + PDV 18,00€  
CIJENA S UKLJUČENIM PDV-OM

-20%

## ENDOMJERKE



107-341



107-341-B

107-341-G

107-341-P

~~12,00€ + PDV~~

~~14,64€~~

9,60€ + PDV

12,00€

CIJENA S UKLJUČENIM PDV-OM

-20%

## DRŽAČI OGLEDALA

102-013-1



102-024-Y



102-021-BC



Dostupne boje:



~~6,60€ + PDV~~

~~8,25€~~

5,28€ + PDV

6,60€

CIJENA S UKLJUČENIM PDV-OM

-20%

~~18,00€ + PDV~~

~~23,50€~~

15,04€ + PDV

18,00€

CIJENA S UKLJUČENIM PDV-OM

-20%

## MEGA FS RHODIUM

Ogledala napravljena od jedne legure nehrđajućeg čelika sa rodiranim antirefleksirajućim premazom



41,00€ + PDV 51,25€  
32,80€ + PDV 41,00€  
CIJENA S UKLJUČENIM PDV-OM

-20%

## SE PLUS OGLEDALCE

Ogledala od nehrđajućeg čelika sa 5x povećanjem, srebrni premaz

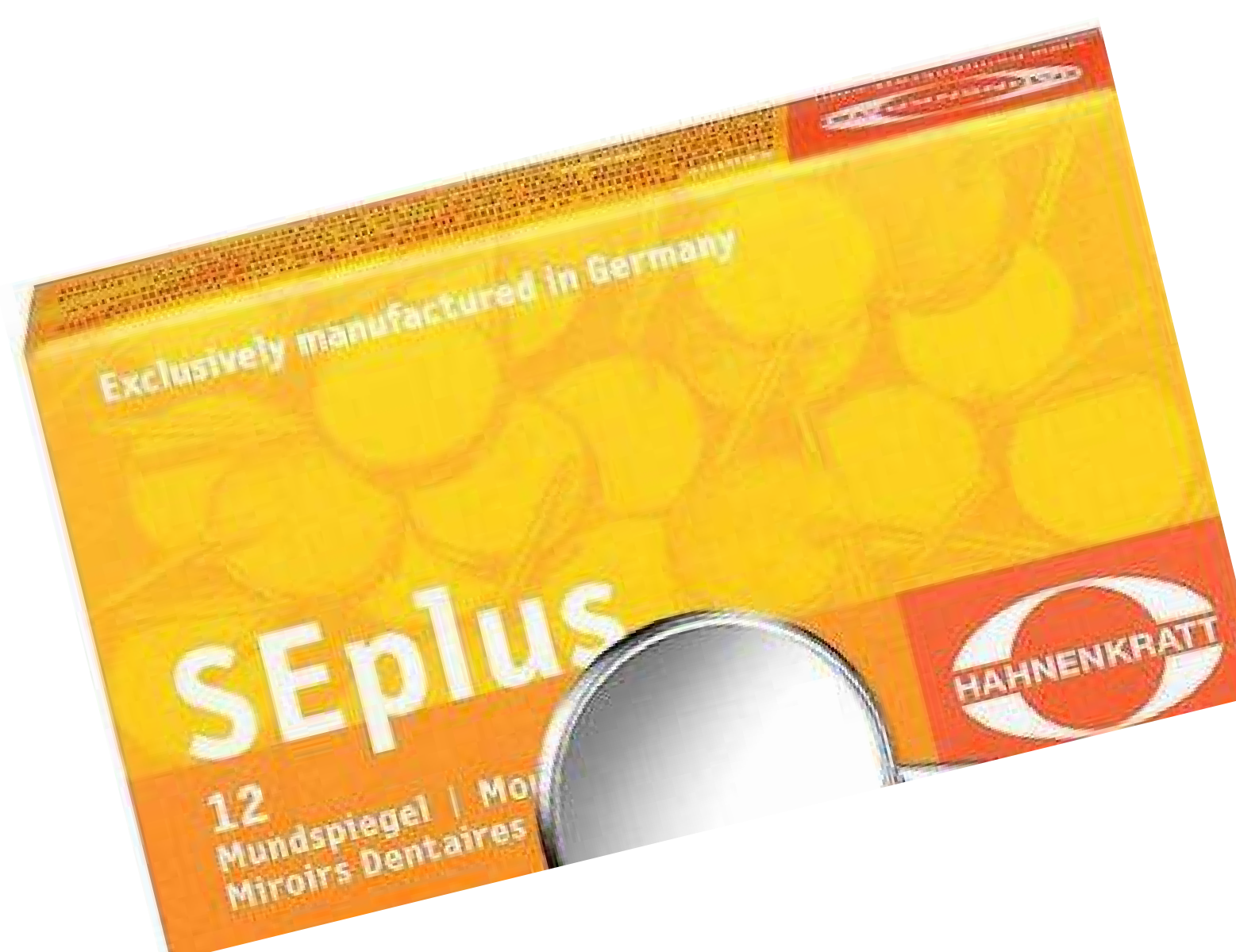

26,00€ + PDV 32,50€  
20,80€ + PDV 26,00€  
CIJENA S UKLJUČENIM PDV-OM

-20%

## TOP VISION OGLEDALCE

Ogledala od nehrđajućeg čelika

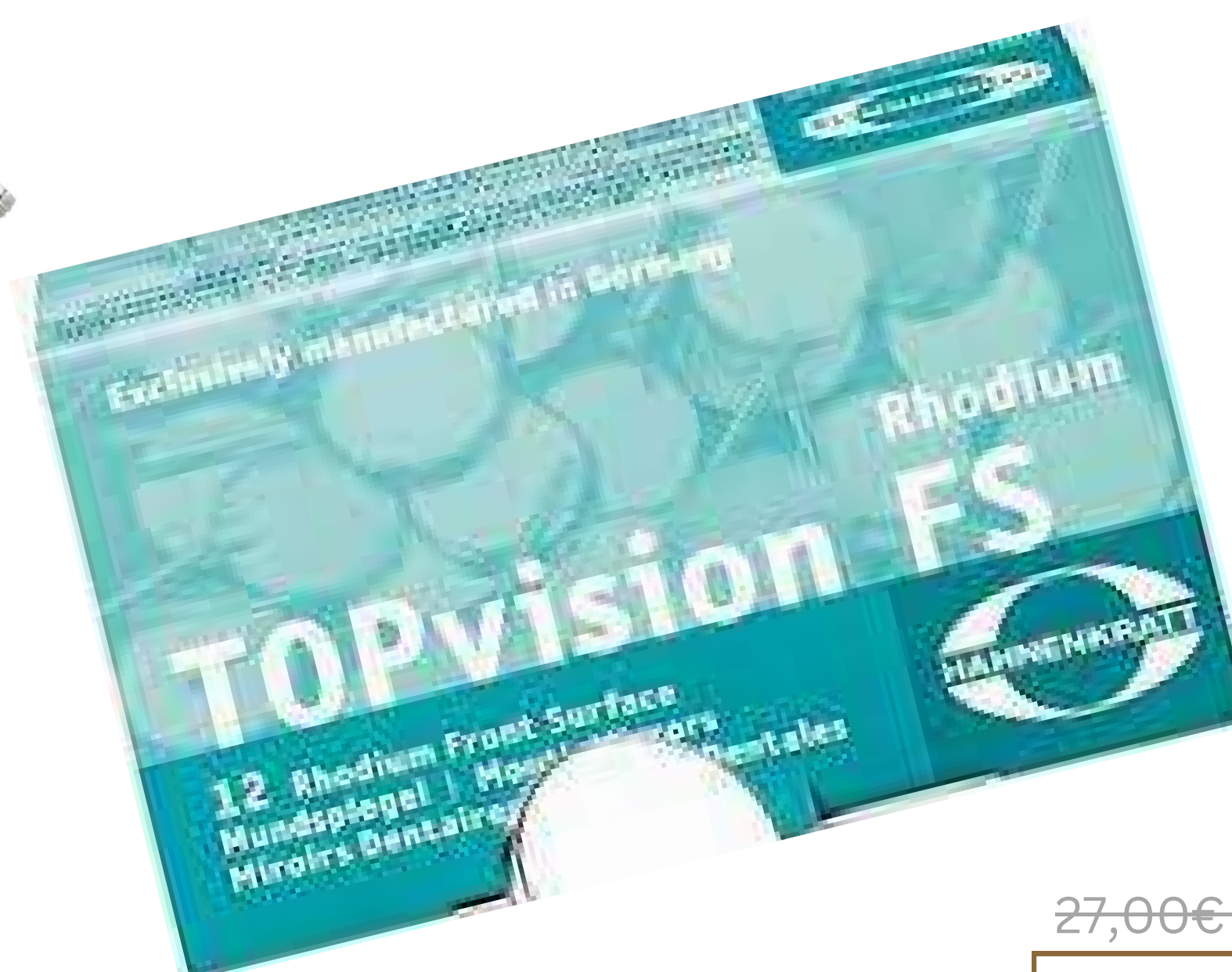

27,00€ + PDV 33,75€  
21,60€ + PDV 27,00€  
CIJENA S UKLJUČENIM PDV-OM

-20%

## RELAX OGLEDALA

Ogledala napravljena od plastike ojačane staklenim vlaknima



54,40€ + PDV 68,00€  
43,52€ + PDV 54,40€  
CIJENA S UKLJUČENIM PDV-OM

-20%

## IVORY MATRICE



• Opcija s 12 ili 100 komada

9,00€ + PDV	11,25€	44,00€ + PDV	55,00€
7,20€ + PDV	9,00€	35,20€ + PDV	44,00€
CIJENA S UKLJUČENIM PDV-OM		CIJENA S UKLJUČENIM PDV-OM	
-20%		-20%	

## TOFFLEMIRE MATRICE

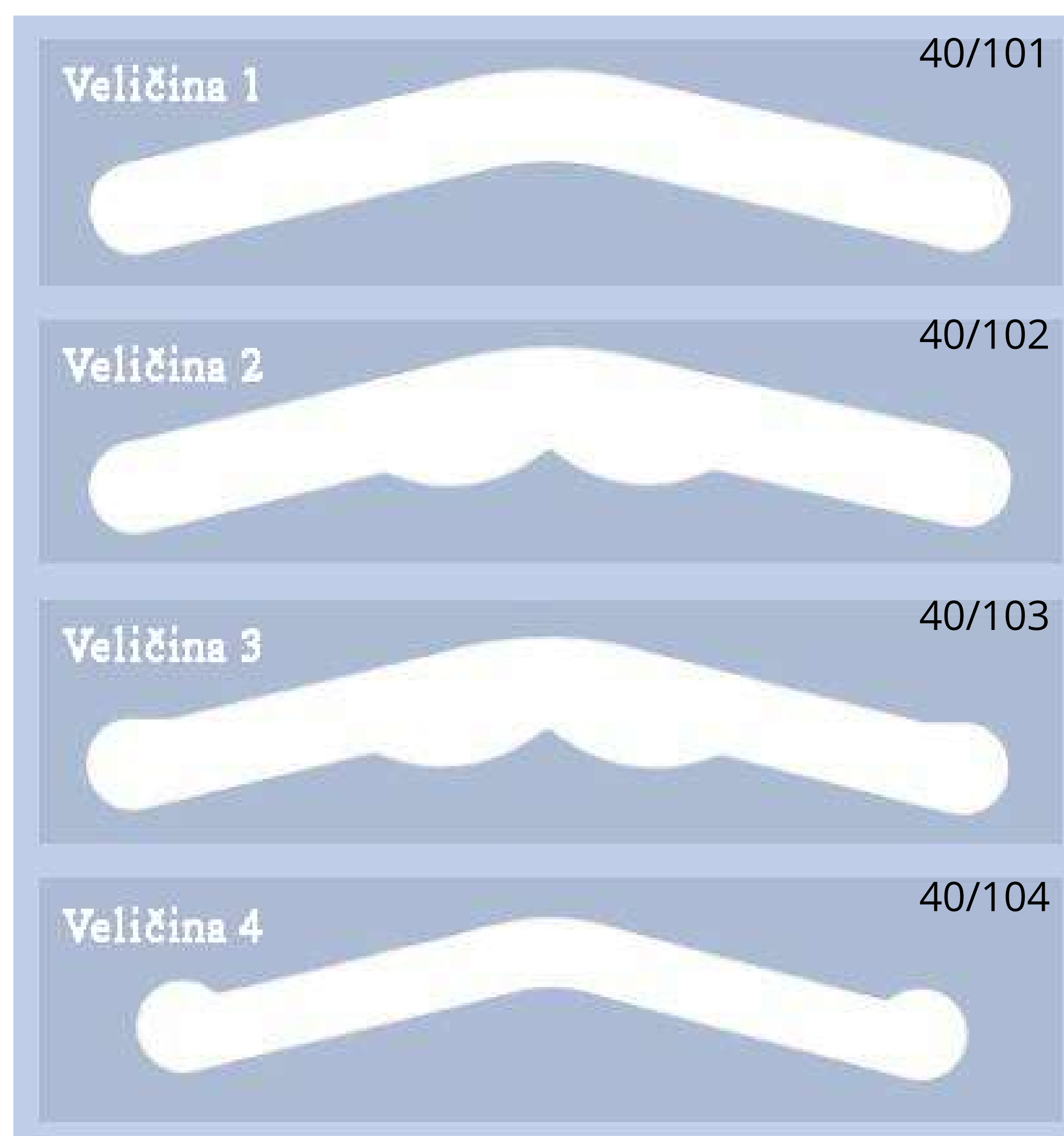

• 12 komada u pakiranju

9,00€ + PDV	11,25€
7,20€ + PDV	9,00€
CIJENA S UKLJUČENIM PDV-OM	
-20%	

## HAHNENKRATT MATRICA U ROLI



veličine: 4mm, 5mm,  
6mm, 7mm

16,00€ + PDV	20,00€
12,80€ + PDV	16,00€
CIJENA S UKLJUČENIM PDV-OM	
-20%	

## STEZAČI MATRICA HAHNENKRATT



40,00€ + PDV	50,00€
32,00€ + PDV	40,00€
CIJENA S UKLJUČENIM PDV-OM	
-20%	

## MATRICE ZA MOLARE



## MATRICE ZA PREMOLARE



- 12 kom u pakiranju
- dostupne različite veličine

9,00€ + PDV ~~11,25€~~  
 7,20€ + PDV 9,00€  
 CIJENA S UKLJUČENIM PDV-OM

-20%

## PERFORIRANE KONTURIRANE MATRICE

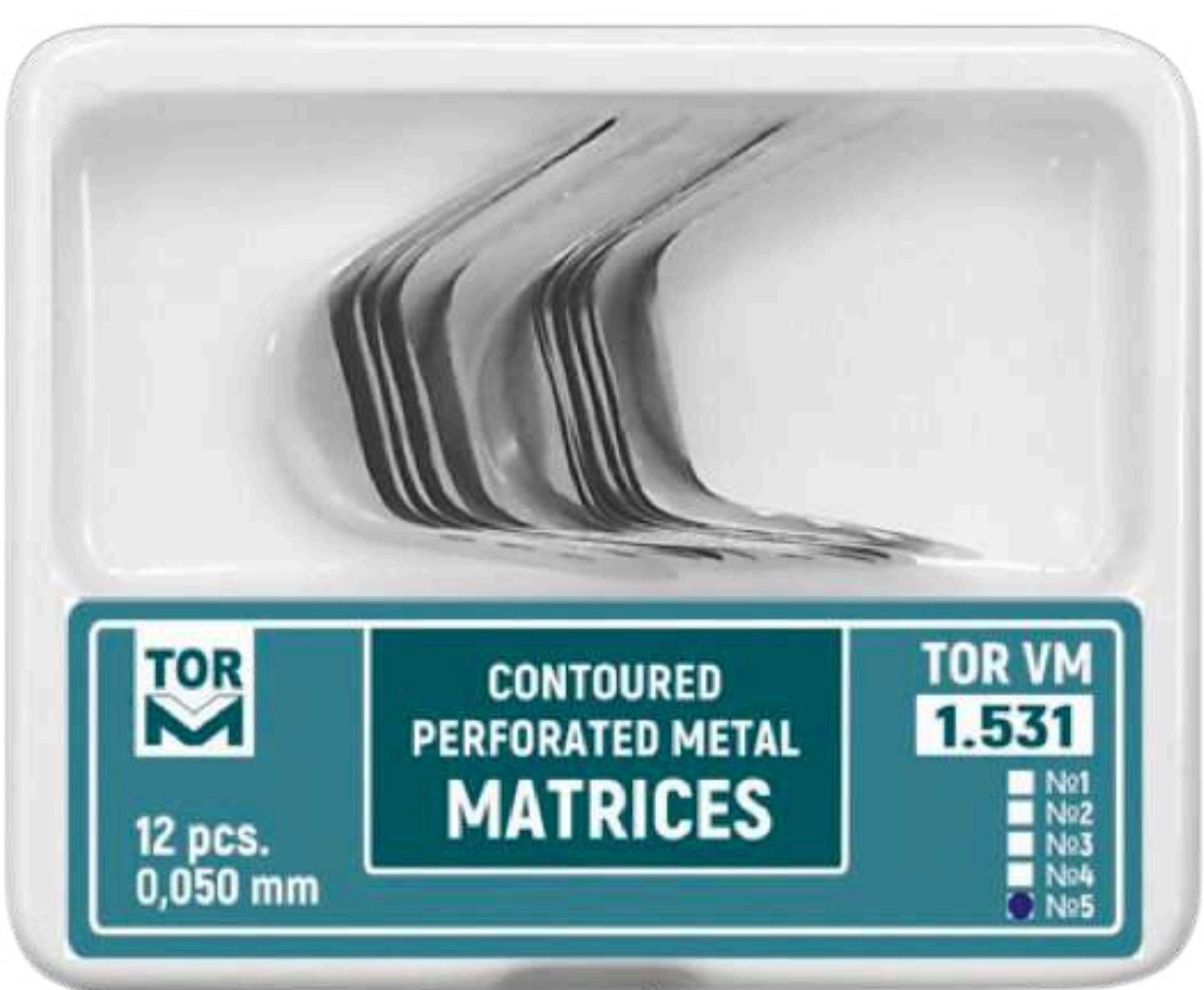

- 12 komada u pakiranju

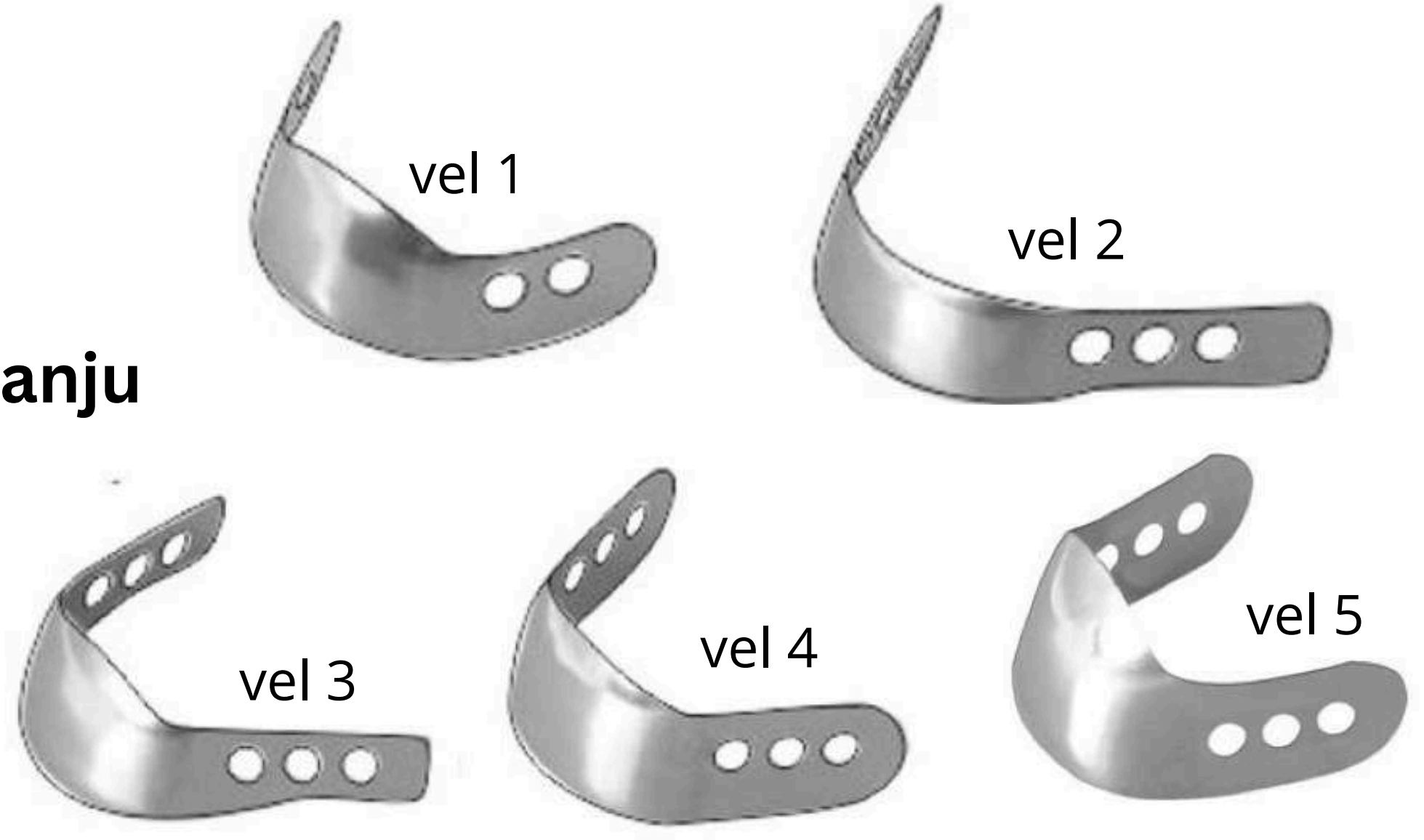

19,00€ + PDV ~~23,75€~~  
 15,20€ + PDV 19,00€  
 CIJENA S UKLJUČENIM PDV-OM

-20%

## SEKCIONALNE KONTURIRANE MATRICE

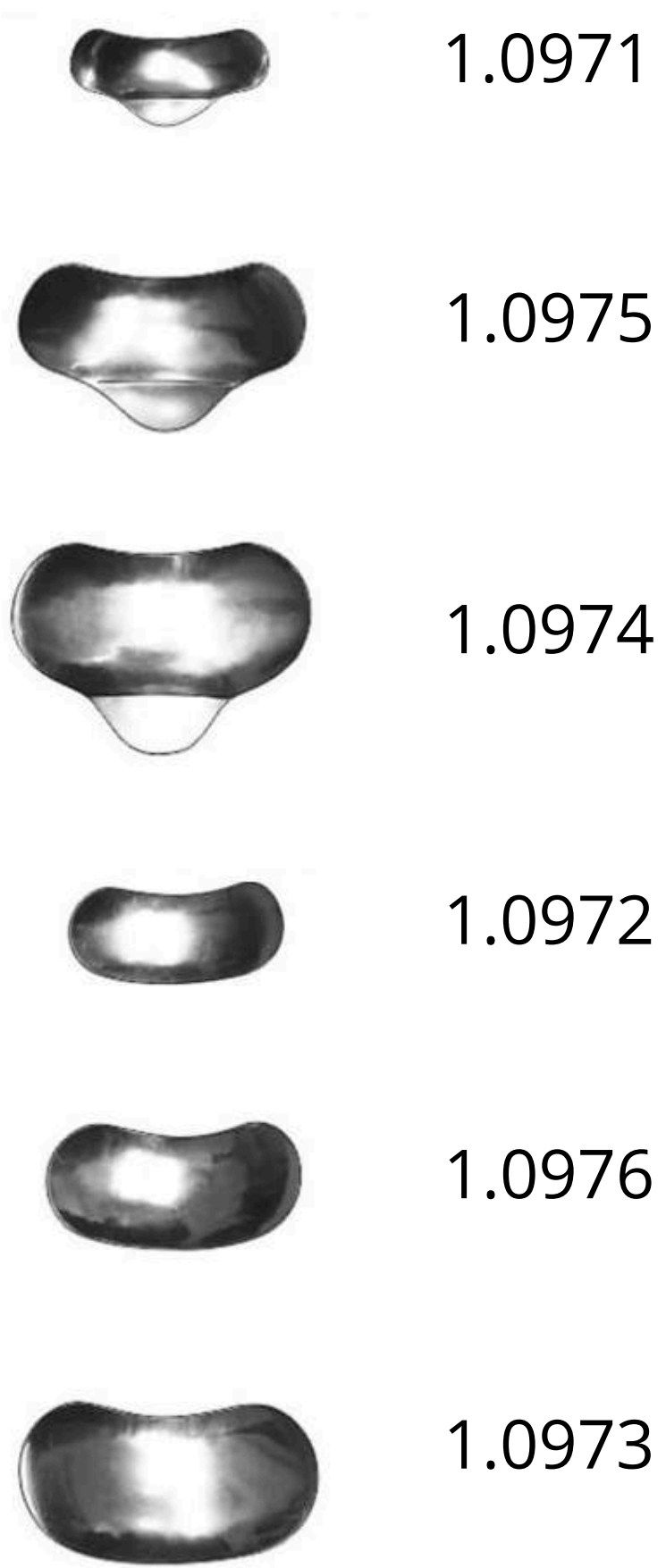

- različite veličine i oblici
- 50 kom u pakiranju

19,00€ + PDV ~~23,75€~~  
 15,20€ + PDV 19,00€  
 CIJENA S UKLJUČENIM PDV-OM

-20%

## SET KONTURIRANIH MATRICA



- set malih matrica 1.1972
- set srednjih matrica 1.1973
- set velikih matrica 1.1976

- 30 kom u pakiranju

19,00€ + PDV ~~23,75€~~  
 15,20€ + PDV 19,00€  
 CIJENA S UKLJUČENIM PDV-OM

-20%

## TOR METALNE STRIPSE



veliĉine:  
1.392 - 6mm  
1.393 - 7mm

6,60 € + PDV 8,25 €

5,28 € + PDV 6,60 €

CIJENA S UKLJUĀENIM PDV-OM

-20%

## TOR TRANSPARENTNE STRIPSE



veliĉine:  
1.244 - 8mm  
1.245 - 10mm

7,60 € + PDV 9,50 €

6,08 € + PDV 7,60 €

CIJENA S UKLJUĀENIM PDV-OM

-20%

## UNIVERZALNI SET KONTURIRANE SEDLO MATRICE

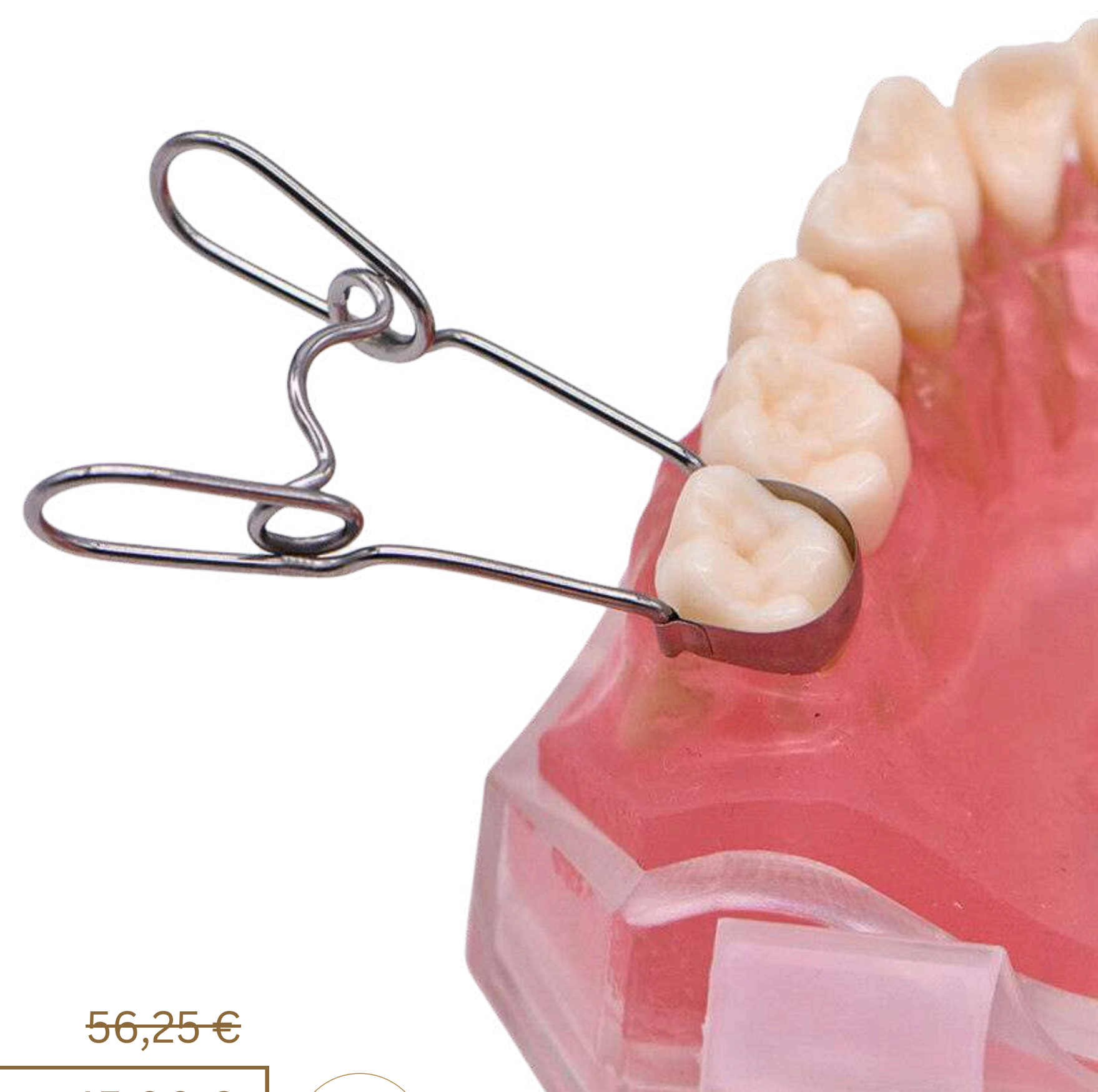

45,00 € + PDV 56,25 €

36,00 € + PDV 45,00 €

CIJENA S UKLJUĀENIM PDV-OM

-20%

### UNIVERZALNI SET / SADDLE METALNE MATRICE

1.330 11 tipova matrica / 36 kom + drĉaĉ za matrice

### UPOJEDINAĀNO PAKIRANJE

Pakiranje od 12 komada

1.311(1) Small



1.312(1) Medium



1.313(1) Large



1.303(1) Large



1.311(2) Small



1.312(2) Medium



1.313(2) Large



1.303(2) Large



7,60 € + PDV 9,50 €

6,08 € + PDV 7,60 €

CIJENA S UKLJUĀENIM PDV-OM

-20%

1.003



14,10 € + PDV 17,63 €

11,28 € + PDV 14,10 €

CIJENA S UKLJUĀENIM PDV-OM

-20%

## SET DISKOVA I STRIPSI



- diskovi različite granulacije 48 kom
- mandrela za diskove
- stripse za poliranje 75 kom

28,00 € + PDV ~~35,00 €~~

22,40 € + PDV 28,00 €  
CIJENA S UKLJUČENIM PDV-OM

-20%

Pojedinačni diskovi, pakiranje 40/50 kom



~~12,90 € + PDV~~ 16,13 €

10,32 € + PDV 12,90 €  
CIJENA S UKLJUČENIM PDV-OM

-20%



~~15,60 € + PDV~~ 19,50 €

12,48 € + PDV 15,60 €  
CIJENA S UKLJUČENIM PDV-OM

-20%



~~13,20 € + PDV~~ 16,50 €

10,56 € + PDV 13,20 €  
CIJENA S UKLJUČENIM PDV-OM

-20%

~~19,80 € + PDV~~ 24,75 €

15,84 € + PDV 19,80 €  
CIJENA S UKLJUČENIM PDV-OM

## PD DISKOVI SOFLEX S MANDRELOM



- Soflex s mandrelom
- srednja ili gruba granulacija

~~37,60 € + PDV~~ 47,00 €

30,08 € + PDV 37,60 €  
CIJENA S UKLJUČENIM PDV-OM

-20%

## HORICO DIJAMANTNE STRIPSE

4 mm F354  
6 mm F356

C354 10 komada  
 C356

~~45,00 € + PDV~~ 56,25 €

36,00 € + PDV 45,00 €  
CIJENA S UKLJUČENIM PDV-OM

-20%



## TOR METALNE STRIPSE

1.150  
GRUBA



1.151  
SREDNJA



1.152  
FINA



-20%

13,76€ + PDV 17,20€

11,00€ + PDV 13,76€  
CIJENA S UKLJUČENIM PDV-OM

## TOR PERFORIRANE DIJAMANTNE STRIPSE

2.150  
GRUBA



2.151  
SREDNJA



2.152  
FINA



-20%

15,68€ + PDV 19,60€

12,54€ + PDV 15,68€  
CIJENA S UKLJUČENIM PDV-OM

## TOR POLIRNE STRIPSE

1.050  
GRUBA



1.051  
SREDNJA



1.052  
FINA



-20%

5,20€ + PDV 6,50€

4,16€ + PDV 5,20€  
CIJENA S UKLJUČENIM PDV-OM

## TOR PILICE



-20%

13,76€ + PDV 17,20€

11,00€ + PDV 13,76€  
CIJENA S UKLJUČENIM PDV-OM

## TOR DRVENI KOLČIĆI SET



27,68€ + PDV 34,60€

22,14€ + PDV 27,68€  
CIJENA S UKLJUČENIM PDV-OM

-20%

## TOR DRVENI KOLČIĆI



VEL: 1,2,3,4,5,6,7

9,00€ + PDV 11,25€

7,20€ + PDV 9,00€  
CIJENA S UKLJUČENIM PDV-OM

-20%

## TOR SILIKONSKI NASTAVAK 1.866 - 40KOM



12,80€ + PDV 16,00€

10,24€ + PDV 12,80€  
CIJENA S UKLJUČENIM PDV-OM

-20%

## TOR SILIKONSKI NASTAVAK 1.861 - 40KOM

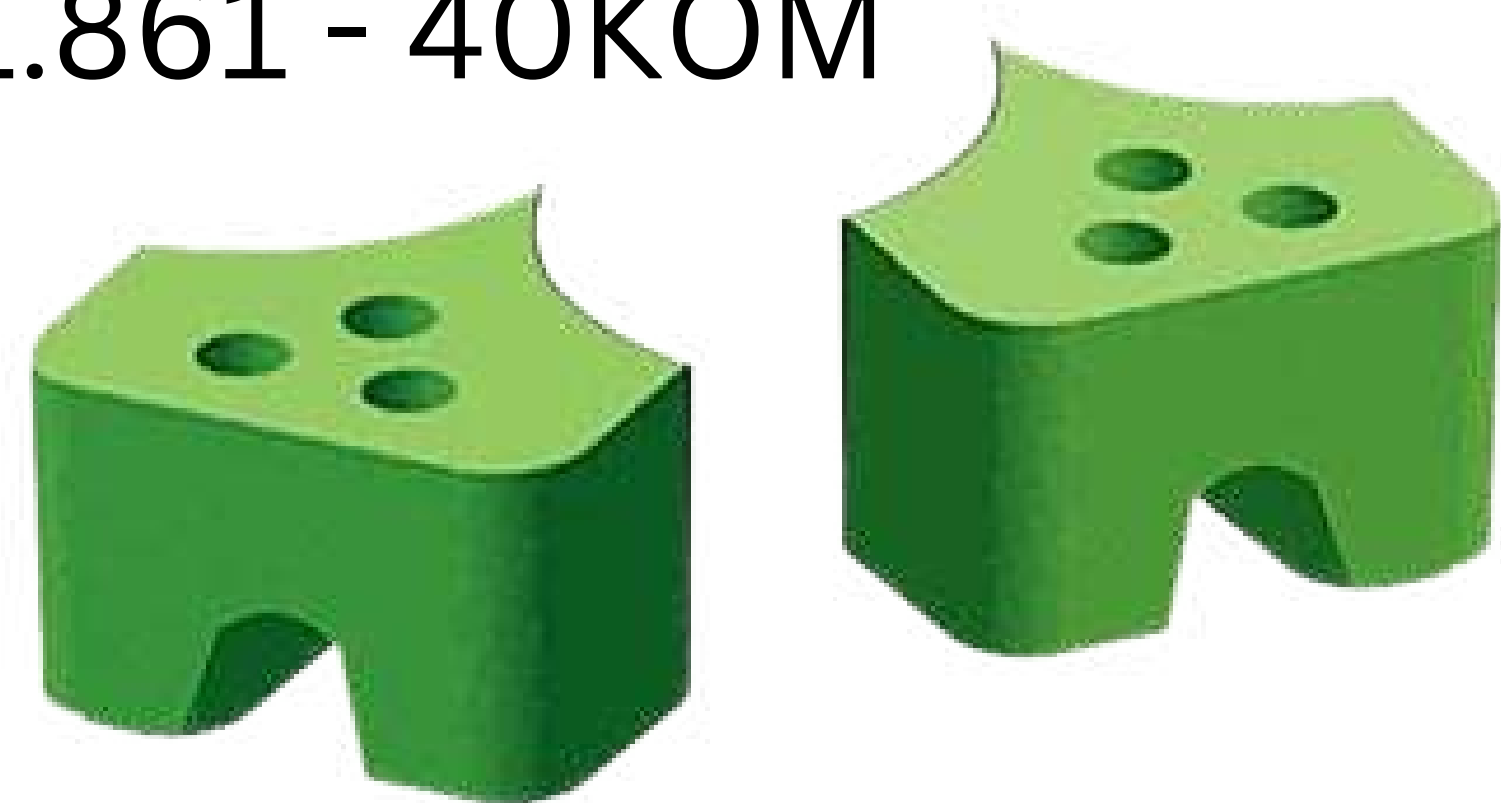

## TOR RING SET



20,79€ + PDV 25,99€

16,63€ + PDV 20,79€  
CIJENA S UKLJUČENIM PDV-OM

-20%

## TOR RING 1.099

VEL: 4,5,6



8,00€ + PDV 10,00€

6,40€ + PDV 8,00€  
CIJENA S UKLJUČENIM PDV-OM

-20%

## TOR RING

SA SILIKONSKIM NASTAVCIMA



25,12€ + PDV 31,40€

20,10€ + PDV 25,12€  
CIJENA S UKLJUČENIM PDV-OM

-20%

# NOVO!!!

## CBCT UREĐAJ - FINSCAN F350

### Dentalna konusno-snopna kompjutorizirana tomografija (CBCT)

- CT snimanje visoke rezolucije u samo 9 sekundi
- Rekonstrukcija HD slike pri manjim dozama skeniranja
- Multiplanarna rekonstrukcija (koronalna, sagitalna i aksijalna ravnina) slike
- Modul za implantate, virtualna ugradnja implantata
- Usklađenje odgovarajućih doza na temelju dobi pacijenta

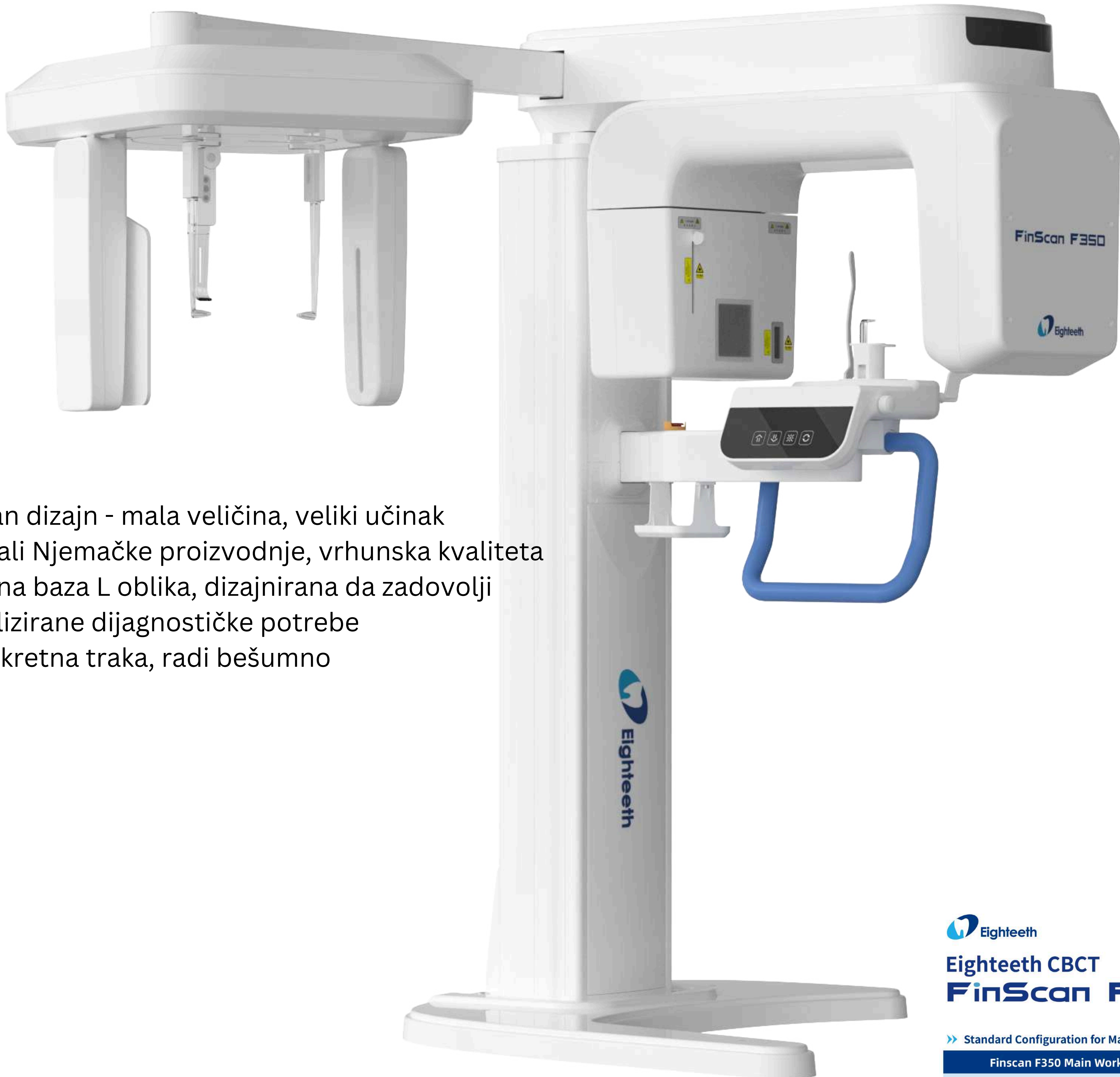

- Pametan dizajn - mala veličina, veliki učinak
- Materijali Njemačke proizvodnje, vrhunska kvaliteta
- Otvorena baza L oblika, dizajnirana da zadovolji specijalizirane dijagnostičke potrebe
- Tiha pokretna traka, radi bešumno



**Eighteeth CBCT  
FinScan F350**  
Broad Vision Easy Acquisition

#### Standard Configuration for Main Workstation

FinScan F350 Main Workstation Configuration			
Model	Dell Chengming 3911 Desktop	Graphics Card	GTX 1660 super 6G
CPU	12th Gen Intel® Core™ i5-12500	Operating System	Windows 11 Home Edition (Genuine)
Memory	Samsung Dual Channel 8GBx2 DDR4	Network	Intel Gigabit Ethernet
System Drive	M.2 256GB Class 35 PCIe NVMe Solid State Drive	Display	Dell 24-inch
Storage Drive	Dell Original 2TB Hard Disk Drive	Screen Resolution	1920x1080

Note: This configuration is for models produced after July 1, 2024. Any changes will be notified separately.

» If there is a need for a triage room to review images in the outpatient department, the computer workstation configuration must meet the following requirements.

Computer configuration requirements for the diagnostic reading workstation			
CPU	Intel Core i3 and above	Display Resolution	1920x1080
Memory	8GB and above	Operating System	Any version of Windows 10/11
Hard Drive	512GB and above	Network	Gigabit Ethernet
Graphics Card	UHD 630 integrated graphics or GeForce GT 730 discrete graphics and above		

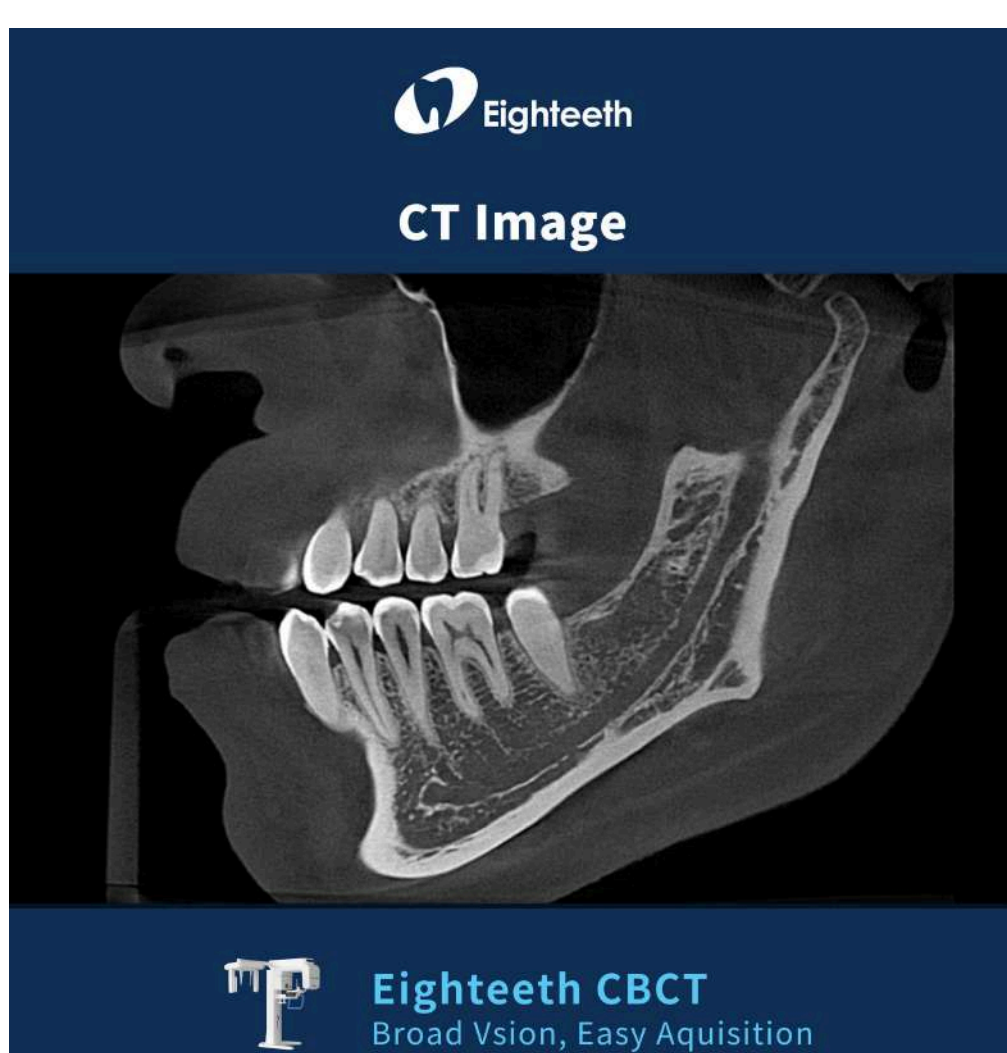

Eighteeth

CT Image

Eighteeth CBCT  
Broad Vision, Easy Acquisition

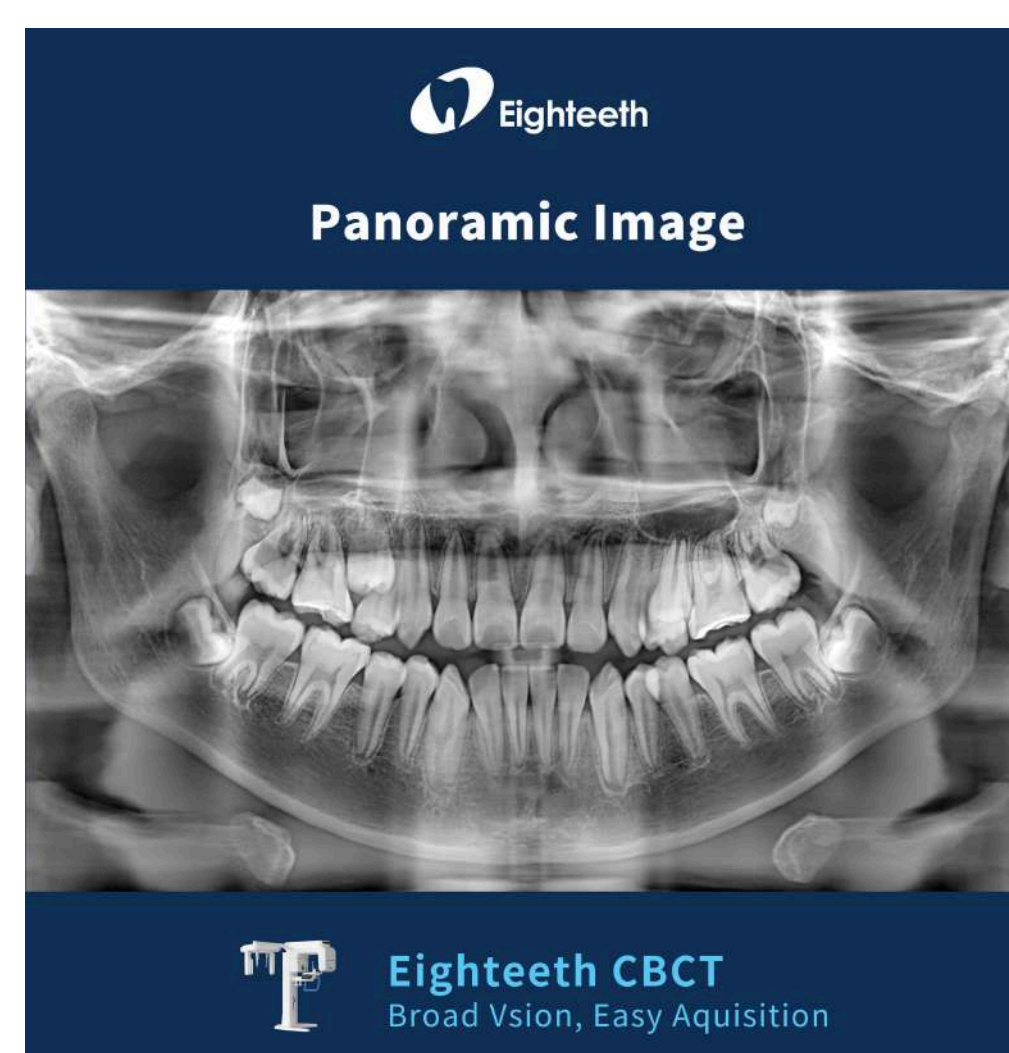

Eighteeth

Panoramic Image

Eighteeth CBCT  
Broad Vision, Easy Acquisition

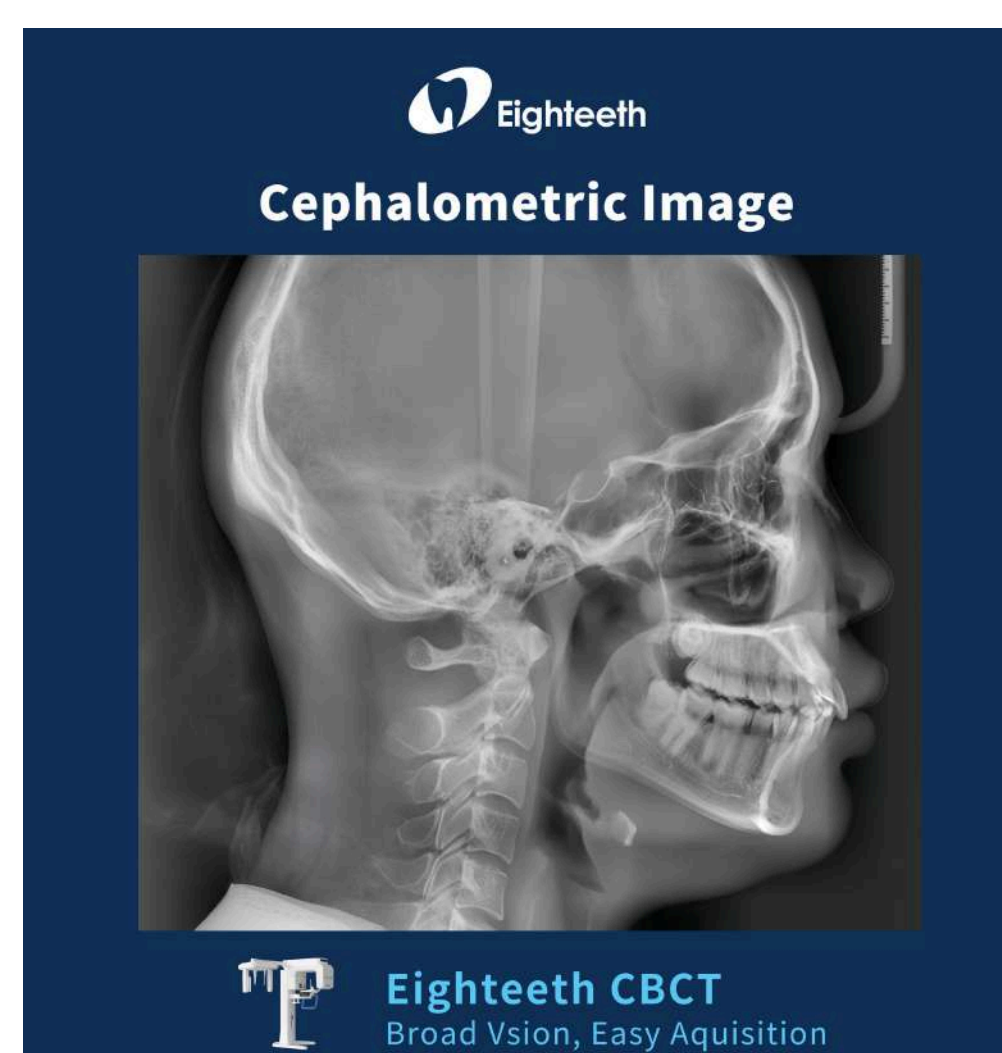

Eighteeth

Cephalometric Image

Eighteeth CBCT  
Broad Vision, Easy Acquisition

CIJENA NA UPIT

# Kontakti

Predstavnik Dalmacija - Božo, mob: 097/709-1944

Predstavnik Rijeka, Istra - Dalibor, mob: 098/408-070

Predstavnik središnja Hrvatska - Marin, mob: 091/158-4957

Predstavnik Zagreb - Stefan, mob: 099/168-4820

Direktor - Teo, mob: 097/780-3373

Ured - mob: 091/619-7408

Pravna služba - Aleksandra, mob: 091/184-7385

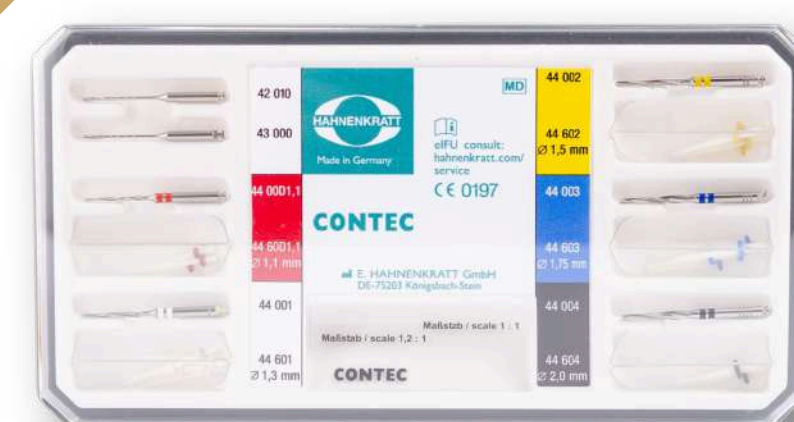

[WWW.FOCUSDENTAL.HR](http://WWW.FOCUSDENTAL.HR)



[INFO@FOCUSDENTAL.HR](mailto:INFO@FOCUSDENTAL.HR)

Eighteeth

FANTA

WILOFA DIAMANT

AR-Instrumed

NT NINETEN

HAHNEKRATT

AKZENTA

EVE

PRESIDENT DENTAL

TOR